

Phase I Mayflower Wind Power Purchase Agreement
Execution Version

OFFSHORE WIND GENERATION UNIT

POWER PURCHASE AGREEMENT

BETWEEN

**MASSACHUSETTS ELECTRIC COMPANY AND NANTUCKET ELECTRIC
COMPANY d/b/a NATIONAL GRID**

AND

MAYFLOWER WIND ENERGY LLC

As of January 10, 2020

TABLE OF CONTENTS

		<u>Page</u>
1.	DEFINITIONS.....	1
2.	EFFECTIVE DATE; TERM.....	17
	2.1 Effective Date.	17
	2.2 Term.....	17
3.	FACILITY DEVELOPMENT AND OPERATION	18
	3.1 Critical Milestones.....	18
	3.2 Delay Damages.	19
	3.3 Construction and Changes in Capacity.....	20
	3.4 Commercial Operation.....	22
	3.5 Operation of the Facility.....	24
	3.6 Interconnection and Delivery Services.....	27
	3.7 Forward Capacity Market Participation.....	28
4.	DELIVERY OF PRODUCTS.....	28
	4.1 Obligation to Sell and Purchase Products.....	28
	4.2 Scheduling and Delivery.....	30
	4.3 Failure of Seller to Deliver Products.....	31
	4.4 Failure by Buyer to Accept Delivery of Products.....	32
	4.5 Delivery Point.....	32
	4.6 Metering.....	33
	4.7 RECs.....	34
	4.8 Test Period.....	35
	4.9 Biennial Average Real-Time High Operating Limit.....	35
5.	PRICE AND PAYMENTS FOR PRODUCTS	36
	5.1 Price for Products.....	36
	5.2 Payment and Netting.....	36
	5.3 Interest on Late Payment or Refund.....	38
	5.4 Taxes, Fees and Levies.....	38
6.	SECURITY FOR PERFORMANCE.....	38
	6.1 Grant of Security Interest.....	38
	6.2 Seller’s Support.....	39
	6.3 Delivery of Credit Support.....	40

REDACTED
TABLE OF CONTENTS (CONT.)

	<u>Page</u>
6.4	Reduction and Substitution of Posted Collateral.40
6.5	Administration of Posted Collateral.....40
6.6	Exercise of Rights Against Posted Collateral44
6.7	Return of Credit Support.....44
7.	REPRESENTATIONS, WARRANTIES, COVENANTS AND ACKNOWLEDGEMENTS44
7.1	Representations and Warranties of Buyer.....44
7.2	Representations and Warranties of Seller.46
7.3	Continuing Nature of Representations and Warranties.48
8.	REGULATORY APPROVAL49
8.1	Receipt of Regulatory Approval.49
9.	BREACHES; REMEDIES49
9.1	Events of Default by Either Party.49
9.2	Events of Default by Seller.50
9.3	Remedies.....53
10.	FORCE MAJEURE56
10.1	Force Majeure.56
11.	DISPUTE RESOLUTION57
11.1	Dispute Resolution.....57
11.2	Allocation of Dispute Costs58
11.3	Consent to Jurisdiction.....58
11.4	Waiver of Jury Trial and Inconvenient Forum Claim.....58
12.	CONFIDENTIALITY.....58
12.1	Nondisclosure.58
12.2	Public Statements.....59
13.	INDEMNIFICATION.....59
13.1	Indemnification Obligations.59
13.2	Notice of Indemnified Claim; Failure to Defend.....60
14.	ASSIGNMENT AND CHANGE OF CONTROL60
14.1	Prohibition on Assignments.....60
14.2	Permitted Assignment by Seller.....60
14.3	Change in Control over Seller.....61
14.4	Permitted Assignment by Buyer.61

REDACTED
TABLE OF CONTENTS (CONT.)

	<u>Page</u>
14.5 Prohibited Assignments.	61
15. TITLE; RISK OF LOSS	61
16. AUDIT	62
16.1 Audit.	62
16.2 Access to Financial Information.	62
17. NOTICES.....	62
18. WAIVER AND MODIFICATION.....	63
19. INTERPRETATION.....	63
19.1 Choice of Law.....	63
19.2 Headings.	63
19.3 Forward Contract.	64
19.4 Standard of Review.....	64
19.5 Change in ISO-NE Rules and ISO-NE Practices.....	64
19.6 Dodd Frank Act Representations.....	64
19.7 Change in Law or Buyer’s Accounting Treatment, Subsequent Judicial or Regulatory Action.....	65
20. CALCULATIONS	66
21. COUNTERPARTS; FACSIMILE OR PDF SIGNATURES	66
22. NO DUTY TO THIRD PARTIES	66
23. SEVERABILITY	66
24. INDEPENDENT CONTRACTOR.....	67
25. ENTIRE AGREEMENT.....	67

Exhibits

Exhibit A	Description of Facility
Exhibit B	Seller’s Critical Milestones – Permits
Exhibit C	Progress Reports
Exhibit D	Products and Pricing
Exhibit E	Related Transmission Facilities
Exhibit F	Required Network Updates
Exhibit G	Metering Process
Exhibit H	Form of Commitment Agreement

POWER PURCHASE AGREEMENT

This **POWER PURCHASE AGREEMENT** (as amended from time to time in accordance with the terms hereof and including all exhibits hereto, this “**Agreement**”) is entered into as of January 10, 2020 (the “**Effective Date**”), by and between Massachusetts Electric Company and Nantucket Electric Company d/b/a National Grid, a Massachusetts corporation (“**Buyer**”), and Mayflower Wind Energy LLC, a Delaware limited liability company (“**Seller**”). Buyer and Seller are individually referred to herein as a “**Party**” and are collectively referred to herein as the “**Parties**”.

WHEREAS, Seller is developing an offshore wind electric generation facility to be located on a portion of the Outer Continental Shelf in Bureau of Ocean Energy Management Lease OCS-A 0521 area, which is more fully described in Exhibit A hereto (the “**Project**”); and

WHEREAS, Buyer’s Percentage Entitlement of the Products (as defined below) is to be delivered to Buyer pursuant to the terms of this Agreement from a portion of the Project, which is more fully described in Exhibit A hereto (the “**Facility**”); and

WHEREAS, the Facility is, and shall qualify as, a RPS Class I Renewable Generation Unit in the Commonwealth of Massachusetts, and the Facility, subject to Sections 4.1(b) and 4.1(c), is eligible to satisfy the CES and the Clean Peak Standard, and the Facility is expected to be in commercial operation by September 1, 2025; and

WHEREAS, pursuant to Section 83C of the Green Communities Act as added by Chapter 188 of the Acts of 2016, An Act to Promote Energy Diversity (“**Section 83C**”), Buyer is authorized to enter into certain long-term contracts for the purchase of energy or energy and renewable energy certificates from offshore wind generators meeting the requirements of Section 83C; and

WHEREAS, Buyer and Seller desire to enter into this Agreement whereby Buyer shall purchase from Seller certain Energy and RECs (each as defined herein) generated by or associated with the Facility; and

WHEREAS, Buyer and Seller have entered into another Power Purchase Agreement dated as the date hereof (the “**Phase II Mayflower Wind Power Purchase Agreement**”), whereby Buyer will purchase from Seller certain energy and environmental attributes generated by or associated with another portion of the Project commencing on a commercial operation date falling later than the Commercial Operation Date (as defined below);

NOW, THEREFORE, in consideration of the premises and of the mutual agreements contained herein, and for other good and valuable consideration, the receipt and sufficiency of which are hereby acknowledged, the Parties hereby agree as follows:

1. DEFINITIONS

In addition to terms defined in the recitals hereto, the following terms shall have the meanings set forth below. Any capitalized terms used in this Agreement and not defined herein shall have the same meaning as ascribed to such terms under the ISO-NE Practices and ISO-NE Rules.

“Actual Facility Size” shall mean the actual nameplate capacity of the Facility, as built, and as certified by an Independent Engineer, as provided in Section 3.4(b)(xiv)(A), as may be increased pursuant to Section 3.3(b) and certified by an Independent Engineer in any Additional Construction IE Certificate delivered pursuant to Section 3.3(b).

“Additional Construction Certificates” shall mean, collectively, (a) the Additional Construction IE Certificate and (b) a Seller’s certification stating that (i) all of the conditions precedent set forth in Section 3.4(b) remain satisfied after giving effect to the portions of the Facility constructed during the Additional Construction Period and (ii) all requirements of the ISO-NE Rules and ISO-NE Practices for the delivery of the Products to Buyer have been satisfied.

“Additional Construction IE Certificate” shall mean an Independent Engineer’s certification stating (a) that (x) the portions of the Facility constructed during the Additional Construction Period have been completed in all material respects (excepting punchlist items that do not affect the ability of the Facility, Network Upgrades, Related Transmission Facilities, Phase II Network Upgrades and Phase II Related Transmission Facilities to operate as intended hereunder) in accordance with this Agreement and are capable of regular commercial operation in accordance with Good Utility Practice and the manufacturer’s guidelines for all material components of the Facility and (y) all performance testing for such portions of the Facility has been successfully completed, and (b) the Actual Facility Size as of such date.

“Additional Construction Period” shall have the meaning set forth in Section 3.3(b) hereof.

“Additional Facilities” shall have the meaning set forth in Exhibit A hereto.

“Adjusted Price” shall mean the purchase price(s) for the Products referenced in Section 5.1 and further described in Exhibit D if Seller has failed to use commercially reasonable efforts consistent with Good Utility Practice to cause the Products provided by Seller to Buyer under this Agreement to qualify and meet the requirements of the RPS, the CES and the Clean Peak Standard as applied to Buyer pursuant to Sections 4.1(b) and 4.1(c) hereof.

“Adverse Determination” shall have the meaning set forth in Section 19.7(b) hereof.

“Affiliate” shall mean, with respect to any Person, any other Person that directly or indirectly through one or more intermediaries Controls, is Controlled by, or is under common Control with, such first Person.

“Agreement” shall have the meaning set forth in the first paragraph hereof.

“Alternative Compliance Payment Rate” shall mean the rate per MWh paid by electricity suppliers under applicable Law for failure to supply RECs in accordance with the RPS.

“**Bid**” shall mean the proposal submitted by Seller for the Facility in response to the Request for Proposals for Long-Term Contracts for Offshore Wind Energy Projects dated May 23, 2019 and issued by Buyer and other Massachusetts distribution companies, as revised August 7, 2019.

“**Biennial Average Real-Time High Operating Limit**” shall have the meaning set forth in Section 4.9 hereof.

“**Business Day**” shall mean a day on which Federal Reserve member banks in New York, New York are open for business; and a Business Day shall start at 8:00 a.m. and end at 5:00 p.m. Eastern Prevailing Time.

“**Buyer**” shall have the meaning set forth in the first paragraph hereof.

“**Buyer’s Percentage Entitlement**” shall mean Buyer’s rights to forty five and forty one hundredths percent (45.41%) of the Products.

“**Buyer’s Taxes**” shall have the meaning set forth in Section 5.4(a) hereof.

“**Capacity Deficiency**” shall mean, at the Commercial Operation Date the amount (expressed in MW), if any, by which the Actual Facility Size as of such date is less than the proposed nameplate capacity of the Facility as set forth in Exhibit A; provided, however, that the Commercial Operation Date shall not occur unless the Actual Facility Size as of the Commercial Operation Date is at least [REDACTED] of the proposed nameplate capacity of the Facility as set forth in Exhibit A.

“**Cash**” shall mean U.S. dollars held by or on behalf of a Party as Posted Collateral hereunder.

“**Catastrophic Failure**” shall mean any failure of any piece of Key Equipment where (i) such failed Key Equipment has been maintained in accordance with Good Utility Practice and all other applicable requirements of this Agreement in all material respects, and (ii) such failure cannot reasonably be expected, in accordance with Good Utility Practice, to be corrected within three (3) months after the occurrence of such failure by Seller using commercially reasonable efforts in accordance with Good Utility Practice.

“**Catastrophic Failure Period**” shall mean (a) with respect to any Key Equipment described in clause (a) of such definition, eighteen (18) consecutive months after the failure of such Key Equipment and (b) with respect to any other Key Equipment, twelve (12) consecutive months after the failure of such Key Equipment.

“**Certificate**” or “**Certificates**” shall mean any electronic certificate created pursuant to the GIS Operating Rules or any successor thereto to represent certain Environmental Attributes of each MWh of Energy generated within the ISO-NE control area and the generation attributes of certain Energy imported into the ISO-NE control area.

“**CES**” shall mean the Clean Energy Standard requirements established pursuant to the regulations promulgated at 310 CMR 7.75 that require all retail electricity suppliers in

Massachusetts to provide a minimum percentage of electricity from certain clean energy generating sources, and such successor laws and regulations as may be in effect from time to time.

“**CES Failure**” shall have the meaning set forth in Section 9.2(k) hereof.

“**CFTC Rules**” shall have the meaning set forth in Section 19.6 hereof.

“**Clean Peak Resource**” shall have the same meaning as in Mass. Gen. Laws ch.25A, Section 3 and any regulations promulgated thereunder, and such successor laws and regulations as may be in effect from time to time.

“**Clean Peak Standard**” shall mean the requirements established pursuant to Mass. Gen. Laws ch.25A, Section 17 and any regulations promulgated thereunder that require all retail electricity suppliers in Massachusetts to provide a minimum percentage of electricity from Clean Peak Resources, and such successor laws and regulations as may be in effect from time to time.

“**Collateral Account**” shall have the meaning set forth in Section 6.5(a)(iii)(B) hereof.

“**Collateral Interest Rate**” shall mean the rate published in *The Wall Street Journal* as the “Prime Rate” from time to time (or, if more than one such rate is published, the arithmetic mean of such rates), or, if such rate is no longer published, a successor rate agreed to by Buyer and Seller, in each case determined as of the date the obligation to pay interest arises, but in no event more than the maximum rate permitted by applicable Law in transactions involving entities having the same characteristics as the Parties.

“**Collateral Requirement**” shall mean at any time the amount of Credit Support required to be provided by Seller under this Agreement at such time.

“**Commercial Operation Date**” shall mean the date on which the conditions set forth in Section 3.4(b) have been satisfied, as set out in a written notice from Seller to Buyer.

“**Commitment Agreement**” shall mean that Voluntary Agreement Commitment Agreement dated as of the date hereof by Seller for the benefit of Buyer, in the form attached hereto as Exhibit H, pursuant to which Seller agrees to negotiate in good faith and to use commercially reasonable efforts to enter into an agreement with any other owner or developer of an offshore wind generation facility that wishes to interconnect with the Related Transmission Facilities to be used by the Facility to Deliver Energy hereunder.

“**Contract Maximum Amount**” shall mean 185.27 MWh per hour of Energy and a corresponding portion of all other Products, as may be adjusted in accordance with Sections 3.3(b) and 3.3(c).

“**Contract Year**” shall mean the twelve (12) consecutive calendar months starting on the first day of the calendar month following the Commercial Operation Date and each subsequent twelve (12) consecutive calendar month period; provided that the first

Contract Year shall include the days in the prior month in which the Commercial Operation Date occurred.

“Control” shall mean the possession, directly or indirectly and independently or jointly, of the power to direct or cause the direction of the management and policies of a Person, whether through the ownership of voting securities, by contract or otherwise. For purposes of this Agreement, (a) each of EDPR Offshore North America, LLC and Shell New Energies US LLC shall be deemed to have Control of Seller if and for so long as (x) such Person beneficially owns fifty percent (50%) or more of the ownership interests, however designated, in Seller or (y) such Persons independently or jointly Control Seller and (b) EDP Renováveis, S.A. shall be deemed to have Control of EDPR Offshore North America, LLC if and for so long as (x) such Person beneficially owns fifty percent (50%) or more of the ownership interests, however designated, in EDPR Offshore North America, LLC or (y) such Person independently or jointly Controls EDPR Offshore North America, LLC. “Controlled by” and “under common Control with” have meanings correlative of the foregoing.

“Cover Damages” shall mean, with respect to any Delivery Failure, an amount equal to (a) the positive net amount, if, any, by which the Replacement Price exceeds the applicable Price that would have been paid for the Products pursuant to Section 5.1 hereof, multiplied by the quantity of that Delivery Failure, plus (b) any other costs incurred by Buyer in purchasing Replacement Energy and/or Replacement RECs due to that Delivery Failure, plus (c) any applicable penalties and other costs assessed by ISO-NE or any other Person against Buyer as a result of that Delivery Failure, plus (d) any other costs and losses incurred by Buyer as a result of that Delivery Failure.

“CPS Failure” shall have the meaning set forth in Section 9.2(l) hereof.

“Credit Support” shall have the meaning set forth in Section 6.2(d) hereof.

“Credit Support Delivery Amount” shall have the meaning set forth in Section 6.3 hereof.

“Credit Support Return Amount” shall have the meaning set forth in Section 6.4 hereof.

“Critical Milestones” shall have the meaning set forth in Section 3.1(a) hereof.

“Custodian” shall have the meaning set forth in Section 6.5(a)(i) hereof.

“Day-Ahead Energy Market” shall have the meaning set forth in the ISO-NE Rules.

“Default” shall mean any event or condition which, with the giving of notice or passage of time or both, could become an Event of Default.

“Default Credit Support” shall mean Credit Support provided by Seller to Buyer under Section 9.2(d), 9.2(j), 9.2(k) or 9.2(l) pursuant to the terms of those sections which

amount must be in addition to any Development Period Security or Operating Period Security required hereunder at any time.

“Defaulting Party” shall mean the Party with respect to which a Default or Event of Default has occurred.

“Delay Damages” shall have the meaning set forth in Section 3.2(a) hereof.

“Deliver” or **“Delivery”** shall mean with respect to (i) Energy, to supply Energy into Buyer’s ISO-NE account at the Delivery Point in accordance with the terms of this Agreement and the ISO-NE Rules, and (ii) RECs, to supply RECs in accordance with Section 4.7(e).

“Delivery Failure” shall have the meaning set forth in Section 4.3 hereof.

“Delivery Point” shall mean the specific location on the Pool Transmission Facilities where Seller shall Deliver its Energy to Buyer, as set forth in Exhibit A hereto.

“Development Period Security” shall have the meaning set forth in Section 6.2(a) hereof.

“Dispute” shall have the meaning set forth in Section 11.1 hereof.

“Disputing Party” shall have the meaning set forth in Section 6.6(a) hereof.

“DOER” shall mean the Massachusetts Department of Energy Resources and its successors.

“Eastern Prevailing Time” shall mean either Eastern Standard Time or Eastern Daylight Time, as in effect from time to time.

“Effective Date” shall have the meaning set forth in the first paragraph hereof.

“Eligibility Failure” shall mean any CES Failure, CPS Failure or RPS Failure.

“Energy” shall mean electric “energy,” as such term is defined in the ISO-NE Tariff, generated by the Facility as measured in MWh in Eastern Prevailing Time, less such Facility’s station service use, generator lead losses and transformer losses, which quantity for purposes of this Agreement will never be less than zero.

“Environmental Attributes” shall mean any and all attributes available under ISO-NE Rules, the RPS, the Clean Peak Standard, the CES, the GWSA and under any and all other international, federal, regional, state or other law, rule, regulation, bylaw, treaty or other intergovernmental compact, decision, administrative decision, program (including any voluntary compliance or membership program), competitive market or business method (including all credits, certificates, benefits, and emission measurements, reductions, offsets and allowances and all other indicia of ownership or control related thereto) or otherwise that are attributable, now or in the future, to Buyer’s Percentage

Entitlement to the favorable generation attributes or environmental attributes of the Facility or the Products produced by the Facility during the Services Term, including Buyer's Percentage Entitlement, to: (a) any such credits, certificates, payments, benefits, offsets and allowances computed on the basis of the Facility's generation using renewable technology or displacement of fossil-fuel derived or other conventional energy generation; (b) any Certificates issued pursuant to the GIS in connection with Energy generated by the Facility; and (c) any voluntary emission reduction credits obtained or obtainable by Seller in connection with the generation of Energy by the Facility; provided, however, that Environmental Attributes shall not in any event include: (i) any state or federal production tax credits; (ii) any state or federal investment tax credits or other tax credits associated with the construction or ownership of the Facility; (iii) any state, federal or private grants, financing, guarantees or other credit support relating to the construction or ownership, operation or maintenance of the Facility or the output thereof; or (iv) any capacity rights associated with the Facility.

“Event of Default” shall have the meaning set forth in Section 9.1 hereof and shall include the events and conditions described in Section 9.1 and Section 9.2 hereof.

“EWG” shall mean an exempt wholesale generator under 42 U.S.C. §§ 16451-16463, as amended from time to time, and FERC's implementing regulations thereunder.

“Facility” shall have the meaning set forth in the recitals hereof.

“FCA” shall have the meaning set forth in Section 3.7 hereof.

“FCAQ” shall have the meaning set forth in Section 3.7 hereof.

“FERC” shall mean the United States Federal Energy Regulatory Commission, and shall include its successors.

“Financial Closing Date” shall mean the date of the closing of the agreements for Financing adequate for construction of the Facility and of an initial disbursement of funds under such agreements.

“Financing” shall mean any direct or indirect funding in connection with any development, bridge, construction, permanent debt or Tax Equity Transaction or refinancing for the Facility, including, without limitation, lease, inverted lease, sale-leaseback, partnership flip, monetization of tax benefits, back leverage financing, credit derivative arrangements, indebtedness, whether secured or unsecured, loans, guarantees, notes, convertible debt, and bond issuances.

“Force Majeure” shall have the meaning set forth in Section 10.1(a) hereof.

“Generation Unit” shall mean a facility that converts a fuel or an energy resource into electrical energy.

“GIS” shall mean the NEPOOL Generation Information System or any successor thereto, which includes a generation information database and certificate system, operated by

NEPOOL, its designee or successor entity, that accounts for generation attributes of electricity generated or consumed within New England.

“GIS Operating Rules” are the NEPOOL Generation Information System Operating Rules effective as of the Effective Date, as amended, superseded, or restated from time to time.

“Good Utility Practice” shall mean compliance with all applicable laws, codes, rules and regulations, all ISO-NE Rules and ISO-NE Practices, and any practices, methods and acts engaged in or approved by a significant portion of the electric industry in New England and by the offshore wind generation industry, as applicable, during the relevant time period, taking into account the technology of the equipment and the environment with respect to which these practices will be applied, or any of the practices, methods and acts which, in the exercise of reasonable judgment in light of the facts known at the time the decision is made, could have been expected to accomplish the desired result consistent with good business practices, reliability, safety and expedition. Good Utility Practice is not intended to be limited to the optimum practice, method or act to the exclusion of all others, but rather is intended to include acceptable practices, methods and acts generally accepted in the electric industry in New England and by the offshore wind generation industry, as applicable, during the relevant time period, taking into account the technology of the equipment and the environment with respect to which these practices will be applied.

“Governmental Entity” shall mean any federal, state or local governmental agency, authority, department, instrumentality or regulatory body, and any court or tribunal, with jurisdiction over Seller, Buyer or the Facility.

“Guaranteed Commercial Operation Date” shall have the meaning set forth in Section 3.1(a)(vi) hereof.

“GWSA” shall mean the Massachusetts Global Warming Solutions Act (Mass. Gen. Laws ch. 298), and such successor laws and regulations as may be in effect from time to time.

“I.3.9 Confirmation” refers to the ISO-NE Tariff Section I.3.9 pertaining to ISO-NE’s approval of proposed plans as specified therein.

“Independent Engineer” shall mean a licensed professional engineer with expertise in the development of renewable energy projects using the same renewable energy technology as the Facility, reasonably selected by and retained by Seller in order to determine the as-built nameplate capacity of the Facility as provided in Sections 3.4(b)(xiv)(A) and 3.3(b) hereof and to provide the certification as to the Facility’s ability to achieve the Commercial Operation Date after the Guaranteed Commercial Operation Date as provided in Section 3.2(a) hereof.

“Indirect Parent Entity” shall mean any indirect owner of Seller.

“**Interconnecting Utility**” shall mean the utility (which may or may not be Buyer or an Affiliate of Buyer) providing interconnection service for the Facility to the Transmission System of that utility.

“**Interconnection Agreement**” shall mean an agreement between Seller and the Interconnecting Utility and ISO-NE, as applicable, regarding the interconnection of the Facility to the Transmission System of the Interconnecting Utility, as the same may be amended from time to time.

“**Interconnection Point**” shall have the meaning set forth in the Interconnection Agreement.

“**Interest Amount**” shall mean with respect to a Party and an Interest Period, the sum of the daily interest amounts for all days in such Interest Period; each daily interest amount to be determined by such Party as follows: (a) the amount of Cash held by such Party on that day (but excluding any interest previously earned on such Cash); multiplied by (b) the Collateral Interest Rate for that day; divided by (c) 360.

“**Interest Period**” shall mean the period from (and including) the last Business Day on which an Interest Amount was Transferred by Buyer (or if no Interest Amount has yet been Transferred by Buyer, the Business Day on which Cash was Transferred to Seller) to (but excluding) the Business Day on which the current Interest Amount is to be Transferred.

“**Internal Bilateral Transaction**” shall mean an “Internal Bilateral for Market for Energy” as defined in the ISO-NE Tariff.

“**ISO-NE**” shall mean ISO New England Inc., the independent system operator established in accordance with the RTO arrangements for New England, or its successor.

“**ISO-NE Practices**” shall mean the ISO-NE practices and procedures for delivery and transmission of energy in effect from time to time and shall include, without limitation, applicable requirements of the NEPOOL Agreement, and any applicable successor practices and procedures.

“**ISO-NE Rules**” shall mean all rules and procedures adopted by NEPOOL, ISO-NE, or the RTO, and governing wholesale power markets and transmission in New England, as such rules may be amended from time to time, including but not limited to, the ISO-NE Tariff, the ISO-NE Operating Procedures (as defined in the ISO-NE Tariff), the ISO-NE Planning Procedures (as defined in the ISO-NE Tariff), the Transmission Operating Agreement (as defined in the ISO-NE Tariff), the ISO-NE Participants Agreement, the manuals, procedures and business process documents published by ISO-NE via its web site and/or by its e-mail distribution to appropriate NEPOOL participants and/or NEPOOL committees, as amended, superseded or restated from time to time.

“**ISO-NE Tariff**” shall mean ISO-NE’s Transmission, Markets and Services Tariff, FERC Electric Tariff No. 3, as amended, superseded or restated from time to time.

“**ISO Settlement Market System**” shall have the meaning as set forth in the ISO-NE Tariff.

“**ITC**” shall mean an investment tax credit generated by investment in certain renewable energy generation assets pursuant to 26 U.S.C. § 48, as amended from time to time.

“**Key Equipment**” shall mean any of the following pieces of equipment included in the Facility (a) the generator step-up transformers at the offshore substation and the transformers at the onshore substation, each as identified on Exhibit A, (b) the metal-clad switchgear, (c) the main circuit breaker, (d) the export cable or (e) the offshore substation.

“**Late Payment Rate**” shall have the meaning set forth in Section 5.3 hereof.

“**Law**” shall mean all federal, state and local statutes, regulations, rules, orders, executive orders, decrees, policies, judicial decisions and notifications.

“**Lender**” shall mean a party providing Financing for the development, construction or ownership of the Facility, or any refinancing of that Financing, and shall include hedge providers and any assignee or transferee of such a party and any trustee, collateral agent or similar entity acting on behalf of such a party.

“**Letter of Credit**” shall mean an irrevocable, non-transferable, standby letter of credit, issued by a Qualified Institution utilizing a form acceptable to the Party in whose favor such letter of credit is issued. All costs relating to any Letter of Credit shall be for the account of the Party providing that Letter of Credit.

“**Letter of Credit Event**” shall mean with respect to an outstanding Letter of Credit, the occurrence of any of the following events (a) the issuer of such Letter of Credit shall fail to be a Qualified Institution; (b) the issuer of the Letter of Credit shall fail to comply with or perform its obligations under such Letter of Credit if such failure shall be continuing after the lapse of any applicable grace period; (c) the issuer of the Letter of Credit shall disaffirm, disclaim, repudiate or reject, in whole or in part, or challenge the validity of, such Letter of Credit; or (d) the Letter of Credit shall expire or terminate or have a Value of \$0 at any time the Party on whose account that Letter of Credit is issued is required to provide Credit Support hereunder and that Party has not Transferred replacement Credit Support meeting the requirements of this Agreement; provided, however, that no Letter of Credit Event shall occur in any event with respect to a Letter of Credit after the time such Letter of Credit is required to be cancelled or returned in accordance with the terms of this Agreement.

“**LMP**” shall have the meaning set forth in the ISO-NE Rules.

“**Marginal Loss Revenue Fund**” shall have the meaning set forth in the ISO-NE Rules.

“**MDPU**” shall mean the Massachusetts Department of Public Utilities and its successors.

“**Meters**” shall have the meaning set forth in Section 4.6(a) hereof.

“**Moody’s**” shall mean Moody’s Investors Service, Inc., and any successor thereto.

“**MW**” shall mean a megawatt alternating current.

“**MWh**” shall mean a megawatt-hour (one MWh shall equal 1,000 kWh).

“**NEPOOL**” shall mean the New England Power Pool and any successor organization.

“**NERC**” shall mean the North American Electric Reliability Corporation and shall include any successor thereto.

“**Network Upgrades**” shall mean upgrades to the Pool Transmission Facilities and all Transmission Providers’ transmission and distribution systems, as determined and identified in the interconnection study approved in connection with construction of the Facility, necessary for Delivery of the Energy to the Delivery Point, including those that are necessary for Seller’s satisfaction of the obligations under Sections 3.6(a) and 3.7 of this Agreement and those that are included in Exhibit F.

“**Node**” shall have the meaning set forth in the ISO-NE Rules.

“**Non-Defaulting Party**” shall mean the Party with respect to which a Default or Event of Default has not occurred.

“**Obligations**” shall have the meaning set forth in Section 6.1 hereof.

“**Operating Period Security**” shall have the meaning set forth in Section 6.2(b) hereof.

“**Operative CPS Change**” shall have the meaning set forth in Section 4.1(b) hereof.

“**Other Facility**” shall mean the “Facility” as defined in the Phase II Mayflower Wind Power Purchase Agreement.

“**Parent Entity**” shall mean any direct or indirect owner of Seller.

“**Party**” and “**Parties**” shall have the meaning set forth in the first paragraph hereof.

“**Permit Failure**” shall have the meaning set forth in Section 9.1(e) hereof.

“**Permits**” shall mean any permit, authorization, license, order, consent, waiver, exception, exemption, variance or other approval by or from, and any filing, report, certification, declaration, notice or submission to or with, any Governmental Entity required to authorize action, including any of the foregoing relating to the ownership, siting, construction, operation, use or maintenance of the Facility under any applicable Law and required for the Delivery of the Products in accordance with this Agreement.

“**Person**” shall mean an individual, partnership, corporation, limited liability company, limited liability partnership, limited partnership, association, trust, unincorporated organization, or a government authority or agency or political subdivision thereof.

“Phase II Mayflower Wind Power Purchase Agreement” shall have the meaning set forth in the recitals hereof.

“Phase II Network Upgrades” shall mean the “Network Upgrades” as defined in the Phase II Mayflower Wind Power Purchase Agreement and described in Exhibit F to the Phase II Mayflower Wind Power Purchase Agreement.

“Phase II Related Transmission Approvals” shall mean the “Related Transmission Approvals” as defined in the Phase II Mayflower Wind Power Purchase Agreement.

“Phase II Related Transmission Facilities” shall mean the “Related Transmission Facilities” as defined in the Phase II Mayflower Wind Power Purchase Agreement and described in Exhibit E to the Phase II Mayflower Wind Power Purchase Agreement.

“Pool Transmission Facilities” has the meaning given that term in the ISO-NE Rules.

“Posted Collateral” shall mean all Credit Support and all proceeds thereof that have been Transferred to or received by a Party under this Agreement and not Transferred to the Party providing the Credit Support or released by the Party holding the Credit Support. Any Interest Amount or portion thereof not Transferred will constitute Posted Collateral in the form of Cash.

“Power Cost Reconciliation Tariff” shall mean a fully reconciling cost recovery tariff mechanism that authorizes the establishment of a distribution charge that fully recovers Buyer’s net costs under this Agreement (including annual remuneration of up to two and three-quarters percent (2.75%)). The rate reconciliation shall be designed in such a way as to limit the build-up of any under or over-recoveries over the course of the year. A reconciliation shall occur at least annually, but may also be reconciled quarterly or monthly, to the extent necessary to eliminate regulatory lag for the recovery of costs or crediting of over-recoveries to customers.

“Price” shall mean the purchase price(s) for Products referenced in Section 5.1 hereof and set forth on Exhibit D.

“Products” shall mean Energy and RECs; provided, however, that Energy and RECs (a) generated by or associated with (x) the Facility during the Test Period or in excess of the Contract Maximum Amount or (y) portions of the Facility that are completed during the Additional Construction Period and generated prior to the delivery of the Additional Construction Certificates or (b) not accepted by Buyer pursuant to Section 4.2(a)(ii) shall not be deemed Products.

“Project” shall have the meaning set forth in the recitals hereof.

“Purchased Power Accounting Authorization” shall mean authorization for Buyer, at Buyer’s sole discretion, to take appropriate steps to assure avoidance of a material, negative balance sheet impact on Buyer or Buyer’s direct or indirect parent company, upon appropriate filing with and approval by the MDPU; provided that such Purchased Power Accounting Authorization shall not impact Buyer’s obligation to purchase the

Products under this Agreement or the Price or Adjusted Price Buyer pays for such Products.

“**QF**” shall mean a cogeneration or small power production facility which meets the criteria as defined by FERC in Title 18, Code of Federal Regulations, §§ 292.201 through 292.207, as amended from time to time.

“**Qualified Institution**” shall mean a major U.S. commercial bank or trust company, the U.S. branch office of a foreign bank, or another financial institution, in any case, organized under the laws of the United States or a political subdivision thereof having assets of at least \$10,000,000,000 and a credit rating of at least (i) “A3” from Moody’s and “A-” from S&P, if such entity is rated by both S&P and Moody’s or (ii) “A-” by S&P or “A3” by Moody’s, if such entity is rated by either S&P or Moody’s but not both.

“**Real-Time Energy Market**” shall have the meaning as set forth in the ISO-NE Rules.

“**RECs**” shall mean all of the Certificates and any and all other Environmental Attributes associated with the Energy or otherwise produced by the Facility including, but not limited to, those which satisfy the RPS for a RPS Class I Renewable Generation Unit, the Clean Peak Standard and the CES, and shall represent title to and claim over all such Environmental Attributes associated with the specified MWh of generation from the Facility.

“**Reference Market-Maker**” shall mean a leading dealer in the relevant market that is selected in a commercially reasonable manner and is not an affiliate of either party.

“**Regulatory Approval**” shall mean the MDPU approval of this entire Agreement (including any amendment of this Agreement as provided for herein), which approval shall include without limitation: (1) confirmation that this Agreement has been approved under Section 83C and the regulations promulgated thereunder and that all of the terms of such Section 83C and such regulations apply to this Agreement; (2) definitive regulatory authorization for Buyer to recover all of its costs incurred under and in connection with this Agreement for the entire term of this Agreement through the implementation of a Power Cost Reconciliation Tariff and/or other cost recovery or reconciliation mechanisms; (3) definitive regulatory authorization for Buyer to recover remuneration of up to two and three-quarters percent (2.75%) of Buyer’s annual payments under this Agreement for the term of this Agreement through the Power Cost Reconciliation Tariff; and (4) approval of any Purchased Power Accounting Authorization requested by Buyer in connection with the Regulatory Approval. Such approval, confirmation and authorizations shall be acceptable in form and substance to Buyer in its sole discretion, shall not include any conditions or modifications that Buyer deems, in its sole discretion, to be unacceptable and shall be final and not subject to appeal or rehearing.

“**Rejected Purchase**” shall have the meaning set forth in Section 4.4 hereof.

“**Related Transmission Approvals**” shall mean those FERC filings, agreements, tariffs and approvals associated with service on the Related Transmission Facilities.

“Related Transmission Facilities” shall mean all facilities and equipment located between Seller’s Generation Unit collector system step-up transformers and the point of change of ownership at the onshore interconnection, including any modification, addition, or upgrades to such facilities and equipment, constructed to physically and electrically interconnect the Seller’s Generation Units to the onshore transmission system, as described in Exhibit E hereto.

“Reliability Curtailment” shall mean any curtailment of Delivery of Energy resulting from (i) an emergency condition as defined in the Interconnection Agreement or the ISO-NE Tariff, or (ii) any other order or directive of the Interconnecting Utility or the Transmission Provider pursuant to an Interconnection Agreement or tariff.

“Replacement Energy” shall mean energy purchased by Buyer as replacement for any Delivery Failure relating to the Energy to be provided hereunder.

“Replacement Price” shall mean (A) the price at which Buyer, acting in a commercially reasonable manner, purchases Replacement Energy and/or Replacement RECs; provided, however, that in no event shall Buyer be required to utilize or change its utilization of its owned or controlled assets, contracts or market positions to minimize Seller’s liability, or (B) if Buyer elects in its sole discretion not to purchase Replacement Energy and/or Replacement RECs, either (x) the market value of energy and/or Replacement RECs, or (y) in the event that Buyer, acting in a commercially reasonable manner, determines that there are no available or suitable Replacement RECs or that there is no market price that can be reasonably determined for Replacement RECs, the Alternative Compliance Payment Rate, in each case as of the date and the time of the Delivery Failure.

“Replacement RECs” shall mean any generation or environmental attributes, including any Certificates or other certificates or credits related thereto reflecting generation by a RPS Class I Renewable Generation Unit and a generating facility eligible to satisfy the CES and the Clean Peak Standard (subject to Sections 4.1(b) and 4.1(c)), generating the same Environmental Attributes as are expected to be generated by the Facility at such time, that are available for purchase by Buyer as replacement for any RECs not Delivered as required hereunder during the Services Term.

“Reporting Party” shall have the meaning set forth in Section 19.6 hereof.

“Request Date” shall have the meaning set forth in Section 6.6(a) hereof.

“Requesting Party” shall have the meaning set forth in Section 6.6(a) hereof.

“Resale Damages” shall mean, with respect to any Rejected Purchase, an amount equal to (a) the positive net amount, if any, by which the applicable Price that would have been paid pursuant to Section 5.1 hereof for such Rejected Purchase, had it been accepted, exceeds the Resale Price multiplied by the quantity of that Rejected Purchase (in MWh and/or RECs, as applicable), plus (b) any applicable penalties assessed by ISO-NE or any other Person against Seller as a result of Buyer’s failure to accept such Products in accordance with the terms of this Agreement, plus (c) transaction and other out-of-pocket

costs and losses incurred by Seller in re-selling such Rejected Purchase that Seller would not have incurred but for the Rejected Purchase.

“**Resale Price**” shall mean the price at which Seller, acting in a commercially reasonable manner, sells or is paid for a Rejected Purchase; provided, however, that (x) in no event shall Seller be required to utilize or change its utilization of the Facility or its other assets, contracts or market positions in order to minimize Buyer’s liability for such Rejected Purchase, and (y) in the event that Seller is unable to sell any Rejected Purchase, the Real-Time Energy Market LMP at the Delivery Point at the time of such Rejected Purchase will be used to calculate the Resale Price for such Rejected Purchase.

“**Rounding Amount**” shall have the meaning set forth in Section 6.2(c) hereof.

“**RPS**” shall mean the requirements established pursuant to Mass. Gen. Laws ch.25A, Section 11F and the regulations promulgated thereunder that require all retail electricity suppliers in Massachusetts to provide a minimum percentage of electricity from RPS Class I Renewable Generation Units, and such successor laws and regulations as may be in effect from time to time.

“**RPS Class I Renewable Generation Unit**” shall mean a Generation Unit termed a “New Renewable Generation Unit” in a Statement of Qualification issued by the DOER pursuant to 225 CMR 14.00.

“**RPS Failure**” shall have the meaning set forth in Section 9.2(j) hereof.

“**RTO**” shall mean ISO-NE and any successor organization or entity to ISO-NE, as authorized by FERC to exercise the functions pursuant to FERC’s Order No. 2000 and FERC’s corresponding regulations, or any successor organization, or any other entity authorized to exercise comparable functions in subsequent orders or regulations of FERC.

“**S&P**” shall mean Standard & Poor’s Financial Services LLC, and any successor thereto.

“**Schedule**” or “**Scheduling**” shall mean the actions of Seller and/or its designated representatives pursuant to Section 4.2, of notifying, requesting and confirming to ISO-NE the quantity of Energy to be delivered on any given day or days (or in any given hour or hours) during the Services Term at the Delivery Point.

“**Section 83C**” shall have the meaning set forth in the recitals hereof.

“**Seller**” shall have the meaning set forth in the first paragraph hereof.

“**Seller’s Taxes**” shall have the meaning set forth in Section 5.4(a) hereof.

“**Services Term**” shall have the meaning set forth in Section 2.2(b) hereof.

“**Settlement Period**” shall have the meaning set forth in Exhibit G hereto.

“**Shared Equipment**” shall have the meaning set forth in Exhibit A hereto.

“Statement of Qualification” shall mean a written document from the DOER that qualifies a Generation Unit as an RPS Class I Renewable Generation Unit, or that qualifies a portion of the annual electrical energy output of a Generation Unit as RPS Class I Renewable Generation (as defined in 225 CMR 14.02).

“Substitute Credit Support” shall have the meaning assigned in Section 6.5(e) hereof.

“Tax Equity Transaction” shall mean, with respect to Seller, any transaction or series of transactions pursuant to which (i) a Person either (A) obtains less than one hundred percent (100%) of the equity interests in Seller or any entity that has an interest in Seller in connection with a partnership flip transaction or (B) obtains all of the equity interests in Seller in connection with a lease, inverted lease or sale-leaseback transaction (in either case, such Person is a **“Tax Equity Investor”**), (ii) such transaction or series of transactions does not result in a change in Control of Seller, subject to the Tax Equity Investor’s right to vote in any major decision with respect to Seller, and (iii) Seller retains control of the Facility.

“Term” shall have the meaning set forth in Section 2.2(a) hereof.

“Termination Payment” shall have the meaning set forth in Section 9.3(b) hereof.

“Test Period” shall have the meaning set forth in Section 3.4(a) hereof.

“Total Actual Facility Size” shall mean the sum of the Actual Facility Size and the “Actual Facility Size” as defined in the Phase II Mayflower Wind Power Purchase Agreement.

“Total Contract Maximum Amount” shall mean the sum of the Contract Maximum Amount and the “Contract Maximum Amount” as defined in the Phase II Mayflower Wind Power Purchase Agreement.

“Transfer” shall mean, with respect to any Posted Collateral or Interest Amount, and in accordance with the instructions of the Party entitled thereto:

- (a) in the case of Cash, payment or transfer by wire transfer into one or more bank accounts specified by the Party to whom such Cash is being delivered; and
- (b) in the case of Letters of Credit, delivery of the Letter of Credit or an amendment thereto to the Party to whom such Letter of Credit is being delivered.

“Transmission Provider” shall mean (a) ISO-NE, its respective successor or Affiliates; (b) Buyer; and/or (c) such other third parties from whom transmission services are necessary for Seller to fulfill its performance obligations to Buyer hereunder, as the context requires.

“**Transmission System**” shall mean the transmission facilities operated by a Transmission Provider, now or hereafter in existence, which provide energy transmission service for the Energy to the point of change of ownership at the onshore interconnection.

“**Unit Contingent**” shall mean that the Products are to be supplied only from the Facility and only to the extent that the Facility is generating Energy.

“**Valuation Agent**” shall mean the Requesting Party; provided, however, that in all cases, if an Event of Default has occurred and is continuing with respect to the Party designated as the Valuation Agent, then in such case, and for so long as the Event of Default continues, the other Party shall be the Valuation Agent.

“**Valuation Date**” shall mean each Business Day.

“**Valuation Percentage**” shall have the meaning set forth in Section 6.2(d) hereof.

“**Value**” shall mean, with respect to Posted Collateral or Credit Support, the Valuation Percentage multiplied by the amount then available under the Letter of Credit to be unconditionally drawn by Buyer.

2. EFFECTIVE DATE; TERM

2.1 Effective Date. Subject in all respects to Article 8, this Agreement is effective as of the Effective Date.

2.2 Term.

(a) The “**Term**” of this Agreement is the period beginning on the Effective Date and ending upon the expiration of the Services Term or the earlier termination of this Agreement in accordance with its terms.

(b) The “**Services Term**” is the period during which Buyer is obligated to purchase Products Delivered to Buyer by Seller commencing on the Commercial Operation Date and continuing for a period of 20 years from the Commercial Operation Date, unless this Agreement is earlier terminated in accordance with the provisions hereof.

(c) At the expiration of the Term or earlier termination of this Agreement pursuant to the terms hereof, the Parties shall no longer be bound by the terms and provisions hereof, except (i) to the extent necessary to make payments of any amounts owed to the other Party arising prior to or resulting from termination of, or on account of a breach of, this Agreement, (ii) to the extent necessary to enforce the rights and the obligations of the Parties arising under this Agreement before such expiration or termination, and (iii) the obligations of the Parties hereunder with respect to confidentiality and indemnification shall survive the expiration or termination of this Agreement.

3. FACILITY DEVELOPMENT AND OPERATION

3.1 Critical Milestones.

(a) Subject to the provisions of Sections 3.1(c), 3.1(d), 3.1(e) and 10.1, commencing on the Effective Date, Seller shall develop the Facility in order to achieve the following milestones (“**Critical Milestones**”) on or before the dates set forth in this Section 3.1(a):

- (i) receipt of all necessary approvals by the Massachusetts Energy Facilities Siting Board for construction and operation of the Facility, the interconnection of the Facility to the Interconnecting Utility and the construction of Network Upgrades, in final form and not subject to appeal or rehearing, by [REDACTED];
- (ii) qualification determination notification under ISO-NE Tariff Section III.13.1.1.2.8 by [REDACTED];
- (iii) receipt of all Permits (other than those referenced in Section 3.1(a)(i)) necessary to construct and operate the Facility, as set forth in Exhibit B, in final form, by [REDACTED];
- (iv) the achievement of the Financial Closing Date or other demonstration to Buyer’s reasonable satisfaction of the financial capability of Seller to construct the Facility, including, as applicable, Seller’s financial obligations with respect to interconnection of the Facility to the Interconnecting Utility and construction of the Network Upgrades, by [REDACTED];
- (v) (A) issuance of a full notice to proceed by Seller to its general contractor and (B) commencement of construction of the Facility by [REDACTED]; and
- (vi) achievement of the Commercial Operation Date by September 1, 2025 (“**Guaranteed Commercial Operation Date**”).

(b) Seller shall provide Buyer with written notice of the achievement of each Critical Milestone within seven (7) days after that achievement, which notice shall include information demonstrating with reasonable specificity that such Critical Milestone has been achieved. Seller acknowledges that Buyer will receive such notice solely to monitor progress toward the Commercial Operation Date, and Buyer shall have no responsibility or liability for the development, construction, operation or maintenance of the Facility.

(c) Seller may elect to extend all of the dates for the Critical Milestones not yet achieved by up to four six-month periods from the applicable dates set forth in Section 3.1(a) by posting additional Development Period Security in an amount equal to \$926,350 (which is \$5,000 per MWh per hour of Contract Maximum Amount) for each such six-month period. Any such election shall be made in a written notice delivered to Buyer on or prior to the first date for

a Critical Milestone that has not yet been achieved (as such date may have previously been extended).

(d) To the extent a Force Majeure event pursuant to Section 10.1 has occurred that prevents Seller from achieving the Critical Milestone obligation specified in Section 3.1(a)(v)(B) by the deadline stated therein or the Commercial Operation Date by the Guaranteed Commercial Operation Date, such Critical Milestone deadline shall be extended for the duration of the Force Majeure event, but under no circumstances shall such extensions of such Critical Milestone due to all Force Majeure events exceed [REDACTED] beyond the date stated in Section 3.1(a)(v)(B) or 3.1(a)(vi), as applicable.

(e) In the event the Regulatory Approval is subject to appeal or rehearing as of the one (1) year anniversary of the Effective Date or is otherwise not received by the one (1) year anniversary of the Effective Date, the date for each Critical Milestone not yet achieved shall be extended on a day-for-day basis for the duration of the delay beyond such one-year period.

(f) The Parties agree that time is of the essence with respect to the Critical Milestones and is part of the consideration to Buyer in entering into this Agreement.

(g) Notwithstanding the other provisions of this Agreement, or the rights of Seller under Sections 3.1(c), 3.1(d), 3.1(e), 3.2 and 10.1, in no event shall the Commercial Operation Date occur after [REDACTED].

3.2 Delay Damages.

(a) If the Commercial Operation Date is not achieved by the Guaranteed Commercial Operation Date (as extended pursuant to Sections 3.1(c), 3.1(d), 3.1(e) and 10.1), Seller shall pay to Buyer damages for each day from and after such date in an amount equal to \$18,527 (which is \$100.00 per MWh per hour of Contract Maximum Amount), commencing on the Guaranteed Commercial Operation Date (as extended pursuant to Sections 3.1(c), 3.1(d), 3.1(e) and 10.1) and ending on the earlier of (i) the Commercial Operation Date, (ii) the date that Buyer exercises its right to terminate this Agreement under Section 9.3, or (iii) the date that is twelve (12) months after the Guaranteed Commercial Operation Date (“**Delay Damages**”). Delay Damages shall be due under this Section 3.2(a) without regard to whether Buyer exercises its right to terminate this Agreement pursuant to Section 9.3; provided, however, that if Buyer exercises its right to terminate this Agreement under Section 9.3, Delay Damages shall be due and owing to the extent that such Delay Damages were due and owing at the date of such termination. Notwithstanding anything in this Section 3.2(a) or Section 9.2(e) to the contrary, the Parties agree that, if the Commercial Operation Date is not achieved by the Guaranteed Commercial Operation Date and, at any time prior to the date on which Buyer exercises its right to terminate this Agreement under Section 9.3, Seller (x) provides an Independent Engineer’s certification, in form and substance reasonably acceptable to Buyer and with reasonable supporting detail and information, stating that the Commercial Operation Date is reasonably likely to occur on or prior to the date that is twelve (12) months after the Guaranteed Commercial Operation Date (as such date may be extended), (y) has exercised its rights to extend the Critical Milestone dates the maximum number of times allowed pursuant to Section 3.1(c), and (z) posts additional Credit Support with a Value of \$6,762,355 (which is equal to

three hundred sixty five (365) days of Delay Damages), then Buyer shall not have any right to terminate this Agreement because of an Event of Default under Section 9.2(e) until the date that is twelve (12) months after the Guaranteed Commercial Operation Date (provided that Seller is paying Delay Damages in accordance with the provision of this Section 3.2(a)).

(b) Each Party agrees and acknowledges that (i) the damages that Buyer would incur due to Seller's delay in achieving the Commercial Operation Date by the Guaranteed Commercial Operation Date would be difficult or impossible to predict with certainty, and (ii) it is impractical and difficult to assess actual damages in the circumstances stated, and therefore the Delay Damages as agreed to by the Parties and set forth herein are a fair and reasonable calculation of such damages. Notwithstanding the foregoing, this Article shall not limit the Termination Payment payable to Buyer if this Agreement is terminated as a result of Seller's failure to achieve the Commercial Operation Date. Any such Termination Payment shall be determined in accordance with Article 9.

(c) By the tenth (10th) day following the end of the calendar month in which Delay Damages first become due and continuing by the tenth (10th) day of each calendar month during the period in which Delay Damages accrue (and the following months if applicable), Buyer shall deliver to Seller an invoice showing Buyer's computation of such damages and any amount due Buyer in respect thereof for the preceding calendar month. No later than ten (10) days after receiving such an invoice, Seller shall pay to Buyer, by wire transfer of immediately available funds to an account specified in writing by Buyer or by any other means agreed to by the Parties in writing from time to time, the amount set forth as due in such invoice. If Seller fails to pay such amounts when due, Buyer may draw upon the Development Period Security or additional Credit Support posted pursuant to Section 3.2(a) for payment of such Delay Damages, and Buyer may exercise any other remedies available for Seller's default hereunder.

3.3 Construction and Changes in Capacity.

(a) Construction of Facility. Seller shall construct the Facility as described in Exhibit A, in accordance with Good Utility Practice, the manufacturer's guidelines for all material components of the Facility and all requirements of the ISO-NE Rules and ISO-NE Practices for the delivery of the Products to Buyer. Seller shall bear all costs related thereto. Seller may contract with other Persons to provide construction functions, so long as Seller maintains overall responsibility for construction of the Facility through the Term.

(b) Capacity Deficiency. To the extent that Seller has constructed the Facility in accordance with Good Utility Practice, and met all other requirements for the Commercial Operation Date under Section 3.4(b) of this Agreement, including, without limitation, the requirement that the Actual Facility Size as of the Commercial Operation Date is at least [REDACTED] of the proposed nameplate capacity of the Facility as set forth in Exhibit A, but a Capacity Deficiency exists on the Commercial Operation Date as permitted by Section 3.4(b), then (i) on the Commercial Operation Date, the Contract Maximum Amount shall be automatically and temporarily reduced commensurate with the Capacity Deficiency, which reduced Contract Maximum Amount shall be stated in a notice from Buyer to Seller, which notice shall be binding absent manifest error, and (ii) Seller shall have a period of [REDACTED] following the Commercial Operation Date to attempt to increase the Actual Facility Size to an

amount not to exceed the proposed nameplate capacity of the Facility as set forth in Exhibit A (the “**Additional Construction Period**”). On the earlier of (A) the date that (I)(x) the portions of the Facility constructed during the Additional Construction Period have been completed in all material respects (excepting punchlist items that do not affect the ability of the Facility, Network Upgrades, Related Transmission Facilities, Phase II Network Upgrades and Phase II Related Transmission Facilities to operate as intended hereunder) in accordance with this Agreement and are capable of regular commercial operation in accordance with Good Utility Practice and the manufacturer’s guidelines for all material components of the Facility, (y) all requirements of the ISO-NE Rules and ISO-NE Practices for the delivery of the Products to Buyer have been satisfied and (z) all performance testing for such portions of the Facility has been successfully completed (provided that all of the conditions precedent set forth in Section 3.4(b) remain satisfied after giving effect to the portions of the Facility constructed during the Additional Construction Period); and (II) Seller has delivered to Buyer the Additional Construction Certificates and certificates of insurance evidencing the coverages required under Section 3.5(i) for the Facility after giving effect to the portions of the Facility constructed during the Additional Construction Period and (B) the last day of the Additional Construction Period, the Contract Maximum Amount and the Operating Period Security shall be automatically and permanently adjusted commensurate with the Actual Facility Size as certified by an Independent Engineer, as provided in Section 3.4(b)(xiv)(A) or in any Additional Construction IE Certificate delivered pursuant to this Section 3.3(b). Notwithstanding anything to the contrary in this Section 3.3(b), (x) the Services Term shall commence on the Commercial Operation Date, and (y) the same Services Term shall apply to the capacity of the Facility constructed as of the Commercial Operation Date and any remaining capacity of the Facility constructed during the Additional Construction Period, and (z) the Services Term shall not be extended for any remaining capacity of the Facility constructed during the Additional Construction Period.

(c) Increase in Facility Size. To the extent that Seller has constructed the Facility in accordance with Good Utility Practice, and met all other requirements under Section 3.4(b) of this Agreement, if the Independent Engineer’s certification pursuant to Section 3.4(b)(xiv)(A) or 3.3(b) provides that the Actual Facility Size exceeds the “Proposed Facility Size” as provided in Exhibit A, Buyer’s Percentage Entitlement will not be recalculated or otherwise affected but the Contract Maximum Amount, Operating Period Security and Default Credit Support requirements under Section 9.2 will be automatically and permanently increased by an amount to reflect Buyer’s Percentage Entitlement of the numerical difference between the Actual Facility Size and such “Proposed Facility Size,” which increased Contract Maximum Amount, Operating Period Security and Default Credit Support requirements shall be stated in a notice from Seller to Buyer, which notice shall be binding absent manifest error. The Total Actual Facility Size shall not in any event exceed [REDACTED].

(d) Progress Reports. Within ten (10) days of the end of each calendar quarter ending after the Effective Date and continuing until the Commercial Operation Date, Seller shall deliver to Buyer a progress report regarding the development, construction and startup of the Facility and Critical Milestones not yet achieved, including projected time to completion of the Facility, in accordance with the requirements attached hereto as Exhibit C, and shall provide supporting documents and detail supporting any claim that a Critical Milestone has been achieved and other documents and details upon Buyer’s request. Seller shall permit Buyer and

its advisors and consultants to review and discuss with Seller and its advisors and consultants such progress reports during business hours and upon reasonable notice to Seller.

(e) Site Access. Buyer and its representatives shall have the right but not the obligation, during business hours and upon reasonable notice to Seller, to inspect the Facility site and view the construction of the Facility (at Buyer’s sole cost, expense and risk). Buyer and its representatives shall comply with Seller’s reasonable site access rules and otherwise act in accordance with Good Utility Practice during any related site visit. Buyer waives any and all claims against Seller or its Affiliates arising out of or related to any site access or inspection by Buyer and its representatives, whether under this Section 3.3(e), Section 4.6(d) or otherwise, except to the extent caused by the negligence, gross negligence, or willful misconduct of Seller or its Affiliates or the failure of Seller or its Affiliates to act in accordance with Good Utility Practice.

(f) Exhibit Updates. Within thirty (30) days after the Network Upgrades are determined by ISO-NE as provided in Section 3.7, Seller shall provide Buyer with an updated version of Exhibit F solely to reflect such Network Upgrades and any other Network Upgrades required for Seller to perform its obligations under this Agreement. Within thirty (30) days after the Commercial Operation Date and after the delivery of each Additional Construction Certificate, as applicable, Seller shall provide Buyer with an updated version of Exhibit A and Exhibit E solely to reflect the Actual Facility Size, the serial number of each turbine included in the Facility, and the Related Transmission Facilities, each as built and configured as of the Commercial Operation Date. Any changes to any Exhibit other than as provided in this Section 3.3(f) will require Buyer’s consent.

3.4 Commercial Operation.

(a) Seller’s obligation to Deliver the Products and Buyer’s obligation to pay Seller for such Products commences on the Commercial Operation Date; provided, that Energy and RECs generated by the Facility prior to the Commercial Operation Date (the “**Test Period**”) shall not be deemed Products.

(b) The Commercial Operation Date shall occur on the date on which the Facility is completed (subject, if applicable, to a Capacity Deficiency) so long as (w) the Actual Facility Size as of the Commercial Operation Date is at least [REDACTED] (which is [REDACTED] of the proposed nameplate capacity of the Facility as set forth in Exhibit A), (x) the Facility is capable of regular commercial operation in accordance with Good Utility Practice and the manufacturer’s guidelines for all material components of the Facility, (y) all requirements of the ISO-NE Rules and ISO-NE Practices for the delivery of the Products to Buyer have been satisfied, and (z) all performance testing for the Facility has been successfully completed, provided Seller has also satisfied the following conditions precedent as of such date:

- (i) completion of all transmission and interconnection facilities and any and all Network Upgrades, including those included in Exhibit F (as may be updated as provided in Section 3.3(f)), and any and all Phase II Network Upgrades, including but not limited to those included in Exhibit F to the Phase II Mayflower Wind Power

Purchase Agreement (as may be updated as provided in Section 3.3(f)) of the Phase II Mayflower Wind Power Purchase Agreement, and final acceptance and authorization to interconnect the Facility from ISO-NE or the Interconnecting Utility in accordance with the fully executed Interconnection Agreement and as required to interconnect the Facility at the Interconnection Point at a level that is capable of satisfying the Network Capability Interconnection Standard and that is equivalent to the Capacity Capability Interconnection Standard both as defined under the ISO-NE Rules;

- (ii) all Related Transmission Facilities and Phase II Related Transmission Facilities are complete and in-service;
- (iii) Seller has obtained and demonstrated possession of all Permits required for the lawful construction and operation of the Facility, for the interconnection of the Facility to the Interconnecting Utility (including any Network Upgrades and any Phase II Network Upgrades) and for Seller to perform its obligations under this Agreement, including but not limited to Permits related to environmental matters, all as set forth on Exhibit B;
- (iv) Seller has obtained qualification by the DOER qualifying the Facility as a RPS Class I Renewable Generation Unit and as a Clean Peak Resource (subject to Sections 4.1(b) and 4.1(c));
- (v) Seller has satisfied all requirements in order to provide for unit-specific accounting of Environmental Attributes, enabling the Massachusetts Department of Environmental Protection to accurately account for the Energy in the state greenhouse gas emissions inventory, created under chapter 298 of the Acts of 2008;
- (vi) all Related Transmission Approvals and Phase II Related Transmission Approvals have been received;
- (vii) Seller has acquired all real property rights needed to construct and operate the Facility, Related Transmission Facilities and Phase II Related Transmission Facilities, to interconnect the Facility to the Interconnecting Utility, to construct the Network Upgrades and the Phase II Network Upgrades (in each case, to the extent that it is Seller's responsibility to do so) and to perform Seller's obligations under this Agreement;
- (viii) Seller (or the party with whom Seller contracts pursuant to Section 3.5(e)) has established all ISO-NE-related accounts and entered into all ISO-NE-related agreements required for the performance

of Seller's obligations in connection with the Facility and this Agreement, which agreements shall be in full force and effect, including the registration of the Facility in the GIS;

- (ix) Seller has provided to Buyer I.3.9 Confirmation from ISO-NE regarding approval of generation entry, has submitted the Asset Registration Form (as defined in ISO-NE Practices) for the Facility to ISO-NE and has taken such other actions as are necessary to effect the Delivery of the Energy to Buyer in the ISO Settlement Market System;
- (x) Seller has successfully completed all pre-operational testing and commissioning in accordance with manufacturer guidelines;
- (xi) Seller has satisfied all Critical Milestones that precede the Commercial Operation Date in Section 3.1;
- (xii) no Default or Event of Default by Seller shall have occurred and remain uncured;
- (xiii) the Facility is owned or leased by, and under the care, custody and control of, Seller;
- (xiv) Seller has delivered to Buyer:
 - (A) an Independent Engineer's certification stating (i) that the Facility has been completed in all material respects (excepting punchlist items that do not affect the ability of the Facility, Network Upgrades, Related Transmission Facilities, Phase II Network Upgrades and Phase II Related Transmission Facilities to operate as intended hereunder) in accordance with this Agreement, and (ii) the Actual Facility Size as of the Commercial Operation Date; and
 - (B) certificates of insurance evidencing the coverages required under Section 3.5(i);
- (xv) Seller has posted additional Credit Support with a Value of \$13,690,875 (which is equal to \$37,500.00 per MWh per hour of Total Contract Maximum Amount); and
- (xvi) Seller has demonstrated that it can reliably transmit real time data and measurements to ISO-NE.

3.5 Operation of the Facility.

(a) Compliance With Utility Requirements. Seller shall comply with, and shall cause the Facility, Related Transmission Facilities and Shared Equipment to comply with,

Good Utility Practice and all applicable rules, procedures, operating policies, criteria, guidelines and requirements imposed by ISO-NE, any Transmission Provider, any Interconnecting Utility, NERC and/or any regional reliability entity, including, in each case, all practices, requirements, rules, procedures and standards related to Seller's construction, ownership, operation and maintenance of the Facility, Related Transmission Facilities and Shared Equipment and its performance of its obligations under this Agreement (including obligations related to the generation, Scheduling, interconnection, and transmission of Energy, and the transfer of RECs), whether such requirements were imposed prior to, on or after the Effective Date. Seller shall be solely responsible for registering as the "Generator Owner and Generator Operator" of the Facility with NERC and any applicable regional reliability entities, as applicable.

(b) Permits. Seller shall maintain or cause to be maintained in full force and effect all Permits necessary for it to perform its obligations under this Agreement, including all Permits necessary to construct, operate and maintain the Facility and all Related Transmission Approvals.

(c) Maintenance and Operation of Facility. Seller shall, at all times during the Term, construct, maintain and operate the Facility and Related Transmission Facilities in accordance with Good Utility Practice and in accordance with Exhibit A to this Agreement. Seller shall bear all costs related thereto. Seller may contract with other Persons to provide construction, operation and maintenance functions, so long as Seller maintains overall responsibility for construction, operation and maintenance of the Facility throughout the Term. Seller shall also cause the Shared Equipment to be constructed, maintained and operated in accordance with Good Utility Practice.

(d) Interconnection Agreement. Seller shall comply with the terms and conditions of the Interconnection Agreement and shall be responsible for obtaining interconnection of the Facility at the Interconnection Point at a level that is capable of satisfying both the Network Capability Interconnection Standard and the equivalent of the Capacity Capability Interconnection Standard under the ISO-NE Rules.

(e) ISO-NE Status. Seller shall, at all times during the Services Term, either: (i) be an ISO-NE "Market Participant" pursuant to the ISO-NE Rules; or (ii) have entered into an agreement with a Market Participant that shall perform all of Seller's ISO-NE-related obligations in connection with the Facility and this Agreement.

(f) Forecasts. Commencing at least thirty (30) days prior to the anticipated Commercial Operation Date and continuing throughout the Term, Seller shall update and deliver to Buyer on an annual basis and in a form reasonably acceptable to Buyer, twelve (12) month rolling forecasts of Energy production by the Facility, which forecasts shall be non-binding and prepared in good faith and in accordance with Good Utility Practice based on historical performance, maintenance schedules, Seller's generation projections and other relevant data and considerations. Any notable changes from prior forecasts or historical energy delivery shall be noted and an explanation provided. The provisions of this section are in addition to Seller's requirements under ISO-NE Rules and ISO-NE Practices, including ISO-NE Operating Procedure No. 5.

(g) RPS Class I Renewable Generation Unit, etc. Subject to Sections 4.1(b) and 4.1(c), Seller shall be solely responsible at Seller's cost for qualifying the Facility as a RPS Class I Renewable Generation Unit and for qualifying the Facility for the CES and the Clean Peak Standard, for satisfying all requirements in order to provide for unit-specific accounting of Environmental Attributes, enabling the Massachusetts Department of Environmental Protection to accurately account for the Energy in the state greenhouse gas emissions inventory, created under chapter 298 of the Acts of 2008, for arranging for providing meter data for the Facility to the Clean Peak Standard program administrator designated by DOER from time to time, and for maintaining such qualifications throughout the Services Term. Subject to Sections 4.1(b) and 4.1(c), Seller shall take all actions necessary to register for and maintain participation in the GIS to register, monitor, track, and transfer RECs eligible to satisfy both the RPS and the Clean Peak Standard. Seller shall provide such additional information as Buyer may reasonably request relating to such qualification and participation and the registration, monitoring, tracking and transfer of RECs.

(h) Compliance Reporting. Within thirty (30) days following the end of each calendar quarter, Seller shall provide Buyer information pertaining to emissions, fuel types, labor information, generation periods and any other information requested by Buyer to the extent required by Buyer to comply with the disclosure requirements contained under applicable law and any other such disclosure regulations which may be imposed upon Buyer during the Term, which information requirements will be provided to Seller by Buyer at least fifteen (15) days before the beginning of the calendar quarter for which the information is required. To the extent Buyer is subject to any other certification or compliance reporting requirement with respect to the Products produced by Seller and delivered to Buyer hereunder, Seller shall provide any information in its possession (or, if not in Seller's possession, available to it and not reasonably available to Buyer) requested by Buyer to the extent required by Buyer to comply with any such reporting requirement.

(i) Insurance. Throughout the Term, and without limiting any liabilities or any other obligations of Seller hereunder, Seller shall secure and continuously carry with an insurance company or companies rated not lower than "A-" by the A.M. Best Company (or any successor thereto) the insurance coverage and with the deductibles that are customary for a generating facility of the type and size of the Facility and as otherwise legally required. By not later than [REDACTED], and at each policy renewal date thereafter, Seller shall provide Buyer with a certificate of insurance which (i) shall include Buyer as an additional insured on each policy, (ii) shall not include the legend "certificate is not evidence of coverage" or any statement with similar effect, (iii) shall evidence an obligation of the insurer to provide Buyer with thirty (30) days prior written notice in the event of cancellation of coverage, and (iv) shall be endorsed by a Person who has authority to bind the insurer. Seller shall provide Buyer with written notice in the event of coverage modifications that are reasonably likely to adversely affect Buyer. If any coverage is written on a "claims-made" basis, the certification accompanying the policy shall conspicuously state that the policy is "claims made."

(j) Contacts. Each Party shall identify a principal contact or contacts, which contact(s) shall have adequate authority and expertise to make day-to-day decisions with respect to the administration of this Agreement.

(k) Compliance with Law. Without limiting the generality of any other provision of this Agreement, Seller shall be responsible for complying with all applicable requirements of Law, including all applicable rules, procedures, operating policies, criteria, guidelines and requirements imposed by FERC and any other Governmental Entity, whether imposed pursuant to existing Law or procedures or pursuant to changes enacted or implemented during the Term, including all risks of operational and environmental matters relating to the Facility or the Facility site. Seller shall indemnify Buyer against any and all claims arising out of or related to such environmental matters and against any costs incurred by Buyer as a result of Seller's violation of any applicable Law, or ISO-NE or NERC requirements. For the avoidance of doubt, Seller shall be responsible for procuring, at its expense, all Permits and governmental approvals required for the construction and operation of the Facility in compliance with applicable requirements of Law.

(l) FERC Status. Seller shall be responsible for ensuring that it is in compliance with all FERC directives and requirements necessary for Seller to fulfill its obligations under this Agreement. As part of Seller's satisfaction of this responsibility, it shall maintain the Facility's status as an EWG (to the extent Seller meets the criteria for such status) at all times on and after the Commercial Operation Date and shall obtain and maintain any requisite authority to sell the output of the Facility at market-based rates, including market-based rate authority to the extent applicable. Notwithstanding a change in Law occurring subsequent to the Effective Date, Seller shall not (i) seek to qualify the Facility as one or more QFs, or (ii) for so long as this Agreement is in effect, assert, any rights Seller may have to require Buyer to purchase or transmit electric power or to pay a specified price for electric power by virtue of a QF status.

(m) Maintenance. No later than (a) the Commercial Operation Date and (b) two months prior to the end of each calendar year thereafter during the Term, Seller shall submit to Buyer a schedule of planned maintenance for the following calendar year for the Facility. Throughout the Term, Seller shall coordinate all planned maintenance with ISO-NE, consistent with ISO-NE Rules, and shall promptly provide applicable information concerning scheduled outages, as determined by ISO-NE, to Buyer. To maximize the value of the Products, to the extent possible and consistent with ISO-NE Rules, Seller (i) shall not schedule maintenance of the Facility during the months of December, January and February, (ii) shall not schedule maintenance requiring more than [REDACTED] of the Facility to be offline at any single time during the months of July and August, (iii) shall not schedule maintenance requiring more than [REDACTED] of the Facility to be offline at any single time during the months of June and September, and (iv) shall operate the Facility so as to maximize energy production during the hours of anticipated peak load and Energy prices in New England and in order to maximize the production of RECs that are eligible under the Clean Peak Standard (subject to Sections 4.1(b) and 4.1(c)); provided, however, that planned maintenance may be scheduled during all such periods to the extent the failure to perform such planned maintenance is contrary to operation of the Facility in accordance with Good Utility Practice.

3.6 Interconnection and Delivery Services.

(a) Seller shall be responsible for all costs associated with Network Upgrades, including, but not limited to, interconnection of the Facility at the Interconnection Point at a level

that is capable of satisfying both the Network Capability Interconnection Standard and the equivalent of the Capacity Capability Interconnection Standard under the ISO-NE Rules (including the construction of those facilities described in Exhibit F), consistent with all standards and requirements set forth by the FERC, ISO-NE, any other applicable Governmental Entity and the Interconnecting Utility. Seller shall be responsible for procuring delivery service to the Delivery Point and all costs associated with it.

(b) Seller shall defend, indemnify and hold Buyer harmless against any and all liabilities, fees, costs and expenses, including but not limited to reasonable attorneys’ fees arising due to Seller’s performance or failure to perform under the Interconnection Agreement or any agreement for delivery service associated with Seller’s performance of its obligations under this Agreement.

3.7 Forward Capacity Market Participation. Seller shall participate in the ISO-NE’s Forward Capacity Auction Qualification (“**FCAQ**”) process for, and take all other necessary and appropriate actions to qualify for, the Forward Capacity Auction (“**FCA**”) for the first full Capacity Commitment Period during the Services Term with a summer Seasonal Claimed Capability and a winter Seasonal Claimed Capability in each case not less than the respective maximum Seasonal Claimed Capabilities as determined by ISO-NE for Seller’s project as described in the Bid, including qualifying the Seasonal Claimed Capabilities described in the Bid for Capacity Capability Interconnection Standard-equivalent interconnection. Notwithstanding the above, actual Seller participation in any FCA or obtaining a Capacity Supply Obligation shall not be required, but may be pursued at the option of Seller. Seller will provide Buyer with copies of all technical reports and studies provided to and/or by ISO-NE as part of the FCAQ process for the Facility, as described in this Section 3.7, at the same time when those materials are provided to and/or by ISO-NE. Seller shall use commercially reasonable efforts, consistent with Good Utility Practice, to maximize the summer and winter Seasonal Claimed Capabilities for the Facility consistent with the technical reports and studies provided to and/or by ISO-NE and with the Bid. Seller will provide Buyer with written notice of the summer and winter Seasonal Claimed Capabilities for the Facility and the Network Upgrades required to satisfy both the Network Capability Interconnection Standard and the equivalent of the Capacity Capability Interconnection Standard at the Interconnection Point at those Seasonal Claimed Capabilities within fifteen (15) days after the determination thereof by ISO-NE.

4. DELIVERY OF PRODUCTS

4.1 Obligation to Sell and Purchase Products.

(a) Beginning on the Commercial Operation Date, Seller shall sell and Deliver, and Buyer shall purchase and receive all right, title and interest in and to, Buyer’s Percentage Entitlement of the Products in accordance with the terms and conditions of this Agreement. The obligations for Seller to sell and Deliver the Products and for Buyer to purchase and receive the same hereunder are Unit Contingent and shall be subject to the operation of the Facility. Seller agrees that Seller will not curtail or otherwise reduce deliveries of the Products in order to sell such Products to other purchasers. To maximize the value of the Products and without limiting the application of Section 4.7(g),

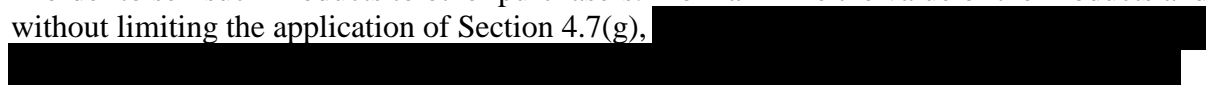

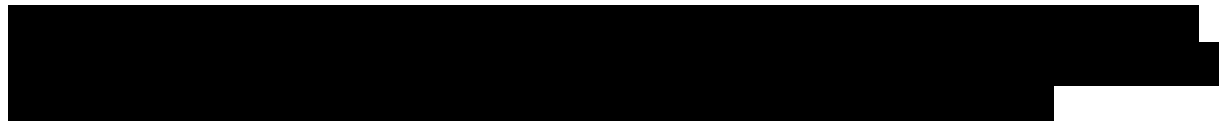

(b) An “**Operative CPS Change**” shall occur if, after the Effective Date (i) there is a change in the Clean Peak Standard regulations relative to those initially proposed by DOER on September 20, 2019, or (ii) there is a change in the guidelines, standards or protocols implementing the Clean Peak Standard regulations relative to those proposed as of the Effective Date, or (iii) new guidelines, standards, or protocols implementing the Clean Peak Standard regulations are adopted. In the event that, solely as a result of an Operative CPS Change, the Products provided by Seller to Buyer from the Facility under this Agreement do not meet the requirements of the Clean Peak Standard and Seller is unable, despite using commercially reasonable efforts consistent with Good Utility Practice, to cause the Products provided by Seller to Buyer under this Agreement to qualify and meet the requirements of the Clean Peak Standard, then Seller will continue to sell and Deliver, and Buyer will continue to purchase, Energy and RECs under this Agreement notwithstanding such change. To the extent Seller has failed to use commercially reasonable efforts consistent with Good Utility Practice to cause the Products provided by Seller to Buyer under this Agreement to qualify and meet the requirements of the Clean Peak Standard as provided above, Buyer shall be entitled to continue to purchase and receive all right, title and interest in and to Buyer’s Percentage Entitlement of the Products at the Adjusted Price specified in Exhibit D. The foregoing shall not be construed to limit any of Buyer’s rights under Section 9.2(l) and Section 9.3 of this Agreement.

(c) In the event that, solely as a result of a change in Law occurring subsequent to the Effective Date, the Products provided by Seller to Buyer from the Facility under this Agreement do not meet the requirements of the RPS, the CES or the Clean Peak Standard, then Seller will continue to sell and Deliver, and Buyer will continue to purchase, Energy and RECs under this Agreement notwithstanding such change in Law, provided that Seller shall use commercially reasonable efforts consistent with Good Utility Practice to cause the Products provided by Seller to Buyer from the Facility under this Agreement to qualify and meet the requirements of the RPS, the CES and the Clean Peak Standard. To the extent Seller has failed to use commercially reasonable efforts consistent with Good Utility Practice to cause the Products provided by Seller to Buyer under this Agreement to qualify and meet the requirements of the RPS, the CES and the Clean Peak Standard as provided above, Buyer shall be entitled to continue to purchase and receive all right, title and interest in and to Buyer’s Percentage Entitlement of the Products at the Adjusted Price specified in Exhibit D. The foregoing shall not be construed to limit any of Buyer’s rights under Section 9.2(j), Section 9.2(k) and Section 9.3 of this Agreement.

(d) Seller shall Deliver Buyer’s Percentage Entitlement of the Products, up to and including the Contract Maximum Amount, exclusively to Buyer, and Seller shall not sell, divert, grant, transfer or assign such Products or any right, claim, certificate or other attribute associated with such Products to any Person other than Buyer during the Term. Seller shall not enter into any agreement or arrangement under which such Products can be claimed by any Person other than Buyer. Buyer shall have the exclusive right to resell or convey the Products in its sole discretion. Buyer shall not purchase Energy or RECs in excess of the Contract Maximum Amount under this Agreement. Notwithstanding anything to the contrary in this

Agreement, nothing in this Agreement shall limit or restrict the right of Seller to sell Energy, RECs and other products, and receive payment therefor, in connection with (i) Energy, RECs and other products that are not Products, (ii) Rejected Purchases, or (iii) an exercise by Seller of its remedies under Section 9.3(a)(ii).

(e) To the extent that Seller receives any payment or other consideration attributable to any Environmental Attributes transferred to Buyer under this Agreement, Seller shall hold such payment or other consideration in trust for the benefit of Buyer and shall promptly remit such payment or other consideration to Buyer in the form so received, or if not transferrable in such form, Seller shall use commercially reasonable efforts to transfer the cash equivalent of such payment or other consideration.

4.2 Scheduling and Delivery.

(a) During the Services Term and in accordance with Section 4.1, Seller shall Schedule and Deliver Energy hereunder with ISO-NE in accordance with this Agreement and all ISO-NE Practices and ISO-NE Rules to Buyer through Internal Bilateral Transactions executed through ISO-NE and settled at the Delivery Point, in accordance with all ISO-NE Practices and ISO-NE Rules. Any such Internal Bilateral Transactions will specify the Buyer's Percentage Entitlement to the actual metered hourly delivery of Energy and will be entered into daily, with any necessary adjustments being made pursuant to ISO-NE settlement protocols, and Seller will not receive any payment associated with a Marginal Loss Revenue Fund allocation in connection with any such Internal Bilateral Transactions. Any such Internal Bilateral Transactions will be entered (x) in the Day-Ahead Energy Market if the Energy is offered by Seller and settled in the Day-Ahead Energy Market, (y) in the Real-Time Energy Market if the Energy is offered by Seller and settled in the Real-Time Energy Market, and/or (z) as reasonably agreed to from time to time by Buyer and Seller, in another ISO-NE energy market to the extent that such other market provides Buyer with additional value for the Energy being purchased hereunder, in each case consistent with ISO-NE Rules and ISO-NE Practices at the time, and Buyer shall have no obligation to pay for any Energy not transferred to Buyer in the Day-Ahead Energy Market or Real-Time Energy Market and/or such other ISO-NE energy market as reasonably agreed to from time to time by Buyer and Seller or for which Buyer is not credited in the ISO Settlement Market System (including, without limitation, as a result of an outage on any electric transmission system). In the event Seller does not have actual metered generation by the Internal Bilateral Transaction initial settlement deadlines, Seller shall Schedule and Deliver Energy through Internal Bilateral Transactions executed through the ISO-NE Data Reconciliation Process. Under no circumstances shall Seller enter estimated generation values into an Internal Bilateral Transaction.

Notwithstanding any other provision of this Agreement:

- (i) if during the Services Term the LMP in the Real-Time Energy Market or the Day-Ahead Energy Market, as applicable, at the Delivery Point is negative, then Seller may deliver to Buyer a written notice stating that such condition has occurred and the period during which such condition has occurred, and in such event Seller shall be under no obligation to schedule or Deliver

Products at the Delivery Point during such negative LMP period;
 and

- (ii) without limiting Buyer’s rights under Sections 9.2 and 9.3, Seller shall promptly notify Buyer of any Eligibility Failure (which shall in any event be not later than twenty-four (24) hours after Seller obtains actual knowledge of such Eligibility Failure), and upon receipt of such notice, Buyer may elect in its sole discretion (1) to continue to accept Delivery of and pay for Buyer’s Percentage Entitlement to any Products generated while that Eligibility Failure is continuing, (2) not to accept Delivery of or pay for the Products generated while that Eligibility Failure is continuing, or (3) to continue to accept Delivery of Buyer’s Percentage Entitlement to the Energy, but not the associated RECs, generated while that Eligibility Failure is continuing, in which case Buyer will pay the Adjusted Price specified in Exhibit D for such Energy, and Seller will (x) pay Buyer the Replacement Price for all RECs not Delivered to Buyer due to such Eligibility Failure or (y) if agreed by Buyer and Seller, deliver Replacement RECs for all RECs not Delivered to Buyer due to such Eligibility Failure.

(b) The Parties agree to use commercially reasonable efforts to comply with all applicable ISO-NE Rules and ISO-NE Practices in connection with the Scheduling and Delivery of Energy hereunder. Without limiting the foregoing, Seller shall submit an Internal Bilateral Transaction for the Energy being Delivered by the applicable scheduling deadline and Buyer shall confirm the Internal Bilateral Transaction submitted by Seller by the applicable scheduling deadline. Penalties or similar charges assessed by a Transmission Provider and caused by Seller’s noncompliance with the Scheduling obligations set forth in this Section 4.2 shall be the responsibility of Seller.

(c) Without limiting the generality of this Section 4.2, Seller or the party with whom Seller contracts pursuant to Section 3.5(e) shall at all times during the Services Term be designated with ISO-NE as the “Lead Market Participant” (or any successor designation) for the Facility and shall be solely responsible for any obligations and liabilities imposed by ISO-NE or under the ISO-NE Rules and ISO-NE Practices with respect to the Facility, including all charges, penalties, financial assurance obligations, losses, transmission charges, ancillary service charges, line losses, congestion charges and other ISO-NE or applicable system costs or charges associated with transmission and delivery. To the extent Buyer incurs such costs, charges, penalties or losses which are the responsibility of Seller, (including amounts not credited to Buyer as described in Section 4.2(a)), Seller shall reimburse Buyer for the same.

4.3 Failure of Seller to Deliver Products. Consistent with the Unit Contingent nature of this Agreement, in the event that the Facility is generating Energy and Seller fails to satisfy any of its obligations to Deliver any of the Products or any portion of the Products hereunder in accordance with Section 4.1, Section 4.2 and Section 4.7, and such failure is not excused under the express terms of this Agreement (a “**Delivery Failure**”) (and without limiting Buyer’s rights under Section 9.2(h) and Section 9.3), Seller shall (i) execute a corrective Internal Bilateral

Transaction for the Energy through ISO-NE and transfer the RECs through the GIS to the extent possible, and (ii) to the extent such a corrective Internal Bilateral Transaction or transfer through the GIS is not executed, pay Buyer an amount for such Delivery Failure (measured in MWh and/or RECs) equal to the Cover Damages for such Delivery Failure. Such payment shall be due no later than the date for Buyer's payment for the applicable month as set forth in Section 5.2 hereof. Each Party agrees and acknowledges that (i) the damages that Buyer would incur due to a Delivery Failure would be difficult or impossible to predict with certainty, and (ii) it is impractical and difficult to assess actual damages in the circumstances stated, and therefore the Cover Damages as agreed to by the Parties and set forth herein is a fair and reasonable calculation of such damages.

4.4 Failure by Buyer to Accept Delivery of Products. If Buyer fails to accept all or part of any of the Products to be purchased by Buyer hereunder, and such failure to accept (a) is not the result of Reliability Curtailment or (b) is not otherwise excused under the terms of this Agreement (a "**Rejected Purchase**"), then Buyer shall pay Seller, on the date payment would otherwise be due in respect of the month in which the failure occurred, an amount for such Rejected Purchase equal to the Resale Damages. Each Party agrees and acknowledges that (i) the damages that Seller would incur due to a Rejected Purchase would be difficult or impossible to predict with certainty, and (ii) it is impractical and difficult to assess actual damages in the circumstances stated, and therefore the Resale Damages as agreed to by the Parties and set forth herein is a fair and reasonable calculation of such damages.

4.5 Delivery Point.

(a) All Energy shall be Delivered hereunder by Seller to Buyer at the Delivery Point. Seller shall be responsible for the costs of delivering its Energy at the Delivery Point consistent with all standards and requirements set forth by the FERC, ISO-NE, and any other applicable Governmental Entity or applicable tariff.

(b) Seller shall be responsible for all applicable charges associated with transmission and interconnection service and delivery of the Energy to and at the Delivery Point, including all related ISO-NE administrative fees, uplift, socialized charges, all costs for Network Upgrades, all costs for Related Transmission Facilities, and all other charges in connection with the satisfaction of Seller's obligations hereunder, including without limitation the Delivery of Energy to and at the Delivery Point. Seller shall indemnify and hold harmless Buyer for any such charges, fees, costs or expenses imposed upon Buyer by operation of ISO-NE Rules or otherwise in connection with Seller's performance of its obligations hereunder.

(c) Buyer shall be responsible for all applicable charges associated with transmission and delivery of the Energy from and after the Delivery Point, provided that Buyer shall have no responsibility or liability for any Network Upgrade or the cost of constructing or upgrading any other transmission or distribution facilities.

(d) Notwithstanding anything herein to the contrary, ISO-NE charges imposed on sellers in an Internal Bilateral Transaction will be the responsibility of Seller, and ISO-NE charges imposed on buyers in an Internal Bilateral Transaction will be the responsibility of Buyer.

4.6 Metering.

(a) Metering. All electric metering associated with the Facility, including the meter at the Delivery Point and any other real-time meters, billing meters and back-up meters (collectively, the “Meters”), shall be installed, operated, maintained and tested at Seller’s expense in accordance with Good Utility Practice and any applicable requirements and standards issued by NERC, the Interconnecting Utility, ISO-NE and DOER or its designated program administrator for the Clean Peak Standard (subject to Sections 4.1(b) and 4.1(c)); provided that each Meter shall be tested at Seller’s expense once each Contract Year. All Meters used to measure the Energy Delivered at the Delivery Point shall be sealed, and Seller shall break the seal only when such Meters are to be inspected and tested (or adjusted) in accordance with this Section 4.6. Seller shall provide Buyer with a copy of all metering and calibration information and documents regarding the Meters promptly following receipt thereof by Seller.



(b) Measurements. Readings of the Meters at the Delivery Point by the Interconnecting Utility in whose territory the Delivery Point is located (or an independent Person mutually acceptable to the Parties) shall be conclusive as to the amount of energy delivered to the Delivery Point by the Facility, the Other Facility and the Additional Facilities, collectively, and readings of gross production at the turbines, as measured through SCADA data of the Facility, the Other Facility and the Additional Facilities, as applicable, shall be conclusive as to the allocation of energy delivered to the Delivery Point by the Facility, the Other Facility and the Additional Facilities, as applicable, as further provided in Exhibit G. Seller, upon request of Buyer and at Buyer’s expense (if more frequently than annually as provided for in Section 4.6(a)), shall cause the Meters to be tested by the Interconnecting Utility in whose territory the Facility is located, and if any Meter is out of service or is determined to be registering inaccurately by more than two percent (2%), (i) the measurement of Energy produced by the Facility shall be adjusted as far back as can reasonably be ascertained, but in no event shall such period exceed six (6) months from the date that such inaccuracy was discovered, in accordance with the filed tariff of such Interconnecting Utility or the ISO-NE Tariff, whichever is applicable, and any adjustment shall be reflected in the next invoice provided by Seller to Buyer hereunder and (ii) Seller shall reimburse Buyer for the cost of such test of the Meters. Meter readings shall be adjusted to take into account the losses to Deliver the Energy at the Delivery Point. Seller shall make recorded meter data available monthly to Buyer at no cost.

(c) Allocation of Energy between the Facility, the Other Facility and the Additional Facilities. The Parties acknowledge and agree that the energy generated by the Facility, the Other Facility and the Additional Facilities will not be capable of separate metering at the Delivery Point, and the electric “energy,” as such term is defined in the ISO-NE Tariff, generated in any Settlement Period by the Facility, the Other Facility and the Additional Facilities as measured in MWh in Eastern Prevailing Time, less such facility’s station service use, generator lead losses and transformer losses, will be allocated among the Facility, the Other Facility and Additional Facilities, and attributed to Energy being purchased by Buyer hereunder

and under the Phase II Mayflower Wind Power Purchase Agreement pursuant to the process described in Exhibit G.

(d) Inspection, Testing and Calibration. Buyer shall have the right to inspect and test (at its own expense) any of the Meters at the Facility at reasonable times and upon reasonable notice from Buyer to Seller (and at Buyer's sole cost and expense), subject to Seller's reasonable site access rules. Buyer shall have the right to have a representative present during any testing or calibration of the Meters at the Facility by Seller (at Buyer's sole cost and expense), subject to Seller's reasonable site access rules. Seller shall provide Buyer with timely notice of any such testing or calibration.

(e) Audit of Meters. Subject to Section 4.6(d), Buyer shall have access to the Meters and the right to audit all information and test data related to such Meters.

(f) Notice of Malfunction. Seller shall provide Buyer with prompt notice of any malfunction or other failure of the Meters or other telemetry equipment necessary to accurately report the quantity of Energy being produced by the Facility. If any Meter is found to be inaccurate by more than two percent (2%), the meter readings shall be adjusted as far back as can reasonably be ascertained, but in no event shall such period exceed six (6) months from the date that such inaccuracy was discovered, and any adjustment shall be reflected in the next invoice provided by Seller to Buyer hereunder.

(g) Telemetry. The Meters shall be capable of sending meter telemetry data, and Seller shall provide Buyer with simultaneous access to such data at no additional cost to Buyer. This provision is in addition to Seller's requirements under ISO-NE Rules and ISO-NE Practices, including ISO-NE Operating Procedure No. 18.

4.7 RECs.

(a) Seller shall transfer to Buyer all of the right, title and interest in and to Buyer's Percentage Entitlement of the Environmental Attributes, including Buyer's Percentage Entitlement of any and all RECs, generated by, or associated with, the Facility during the Services Term in accordance with the terms of this Section 4.7.

(b) Except as provided in Sections 4.1(b) and 4.1(c), all Energy and RECs provided by Seller to Buyer from the Facility under this Agreement shall meet the requirements for eligibility pursuant to the RPS, the CES and the Clean Peak Standard.

(c) At Seller's sole cost, Seller shall also obtain and maintain throughout the Services Term qualification as a class I generation resource (or comparable designation enabling recognition of Environmental Attributes) under (i) the renewable portfolio standard or similar law of each of Connecticut, Maine, New Hampshire and Rhode Island, in each case to the extent the renewable energy technology used in the Facility is eligible under such renewable portfolio standard or similar law or program and (ii) the renewable portfolio standard or similar law of New York and any federal renewable energy standard, in each case to the extent the Facility as built and configured as of the Commercial Operation Date qualifies under such renewable portfolio standard or similar law or program. Seller shall also submit to Buyer, as directed by

Buyer, any information required by any state or federal agency with regard to administration of its rules regarding Environmental Attributes or its renewable energy standard, clean energy standard or renewable portfolio standard or Seller's qualification under the foregoing.

(d) Seller shall comply with all GIS Operating Rules, including without limitation such GIS Operating Rules relating to the creation, tracking, recording and transfer of all RECs to the extent necessary for Seller to perform its obligations under this Agreement. In addition, at Buyer's request, Seller shall register with and comply with the rules and requirements of any other tracking system or program that tracks, monetizes or otherwise creates or enhances value for Environmental Attributes, which compliance shall be at Seller's sole cost if such registration and compliance is requested in connection with Section 4.7(c) above and shall be at Buyer's sole cost in other instances.

(e) Prior to the delivery of any Energy hereunder, either (i) Seller shall cause Buyer to be registered in the GIS as the initial owner of all Certificates to be Delivered hereunder to Buyer or (ii) Seller and Buyer shall effect an irrevocable Forward Certificate Transfer (as defined in the GIS Operating Rules) of the Certificates to be Delivered hereunder to Buyer in the GIS for the Services Term; provided, however, that no payment shall be due to Seller for any RECs until either (x) the Certificates are actually deposited in Buyer's GIS account or a GIS account designated by Buyer to Seller in writing, or (y) (i) Buyer and Seller enter such an irrevocable Forward Certificate Transfer of the Certificates to be Delivered to Buyer in the GIS, which Forward Certificate Transfer shall be denoted in the GIS as not being capable of rescission by Seller, and (ii) the Energy with which such RECs are associated has been Delivered to Buyer.

(f) The Parties intend for the transactions entered into hereunder to be physically settled, meaning that the RECs are intended to be Delivered in the GIS account of Buyer or its designee as set forth in this Section 4.7.

(g) Without limiting the applicability of Section 4.7(c), promptly following a request by Buyer, Seller shall (i) at Seller's sole cost, provide such information or take such administrative or ministerial action (including without limitation filing with or reporting to any Governmental Entity or other Person) and (ii) at Buyer's sole cost, take such other commercially reasonable action, in each case of clauses (i) and (ii), that may be necessary or desirable for Seller to Deliver Environmental Attributes to Buyer or to enable Buyer to use, monetize or otherwise create or enhance value for Environmental Attributes; provided that Seller shall have no obligation to take any action that would have a material adverse effect on Seller's revenues or assumed risks or the operation or physical configuration of the Facility as determined by Seller in good faith considering the allocation of costs under this Section 4.7(g).

4.8 Test Period. During the Test Period, Seller shall not sell and Deliver to Buyer, and Buyer shall not purchase and receive, any Energy or RECs produced by or associated with the Facility. Any Energy or RECs produced by or associated with the Facility during the Test Period may be sold to a Person other than Buyer.

4.9 Biennial Average Real-Time High Operating Limit. Not later than thirty (30) days after the end of each Contract Year beginning with the second Contract Year, Seller shall provide Buyer with a certificate of an officer of Seller setting forth the average hourly Real-Time

High Operating Limit (as defined in the ISO-NE Rules) for such Contract Year and the immediately preceding Contract Year (the “**Biennial Average Real-Time High Operating Limit**”), each as reported to ISO-NE from time-to-time in accordance with the ISO-NE Rules, which certificate shall include information demonstrating with reasonable specificity the calculations made by Seller to determine such average hourly Real-Time High Operating Limit. For purposes of calculating the Biennial Average Real Time High Operating Limit, if Seller reports to ISO-NE a Real-Time High Operating Limit representing an aggregate Real-Time High Operating Limit for the combination of the Facility, the Other Facility and any Additional Facilities, the Biennial Real-Time Operating Limit will represent the equivalent limit determined for the Facility based on the turbine-specific limitations used by Seller to calculate that aggregate Real-Time High Operating Limit.

5. PRICE AND PAYMENTS FOR PRODUCTS

5.1 **Price for Products.** All Products Delivered to Buyer in accordance with this Agreement shall be purchased by Buyer at the Price specified in Exhibit D; provided, however, that to the extent Seller has failed to use commercially reasonable efforts consistent with Good Utility Practice to cause the Products provided by Seller to Buyer under this Agreement to qualify and meet the requirements of the RPS, the CES and the Clean Peak Standard as applied to Buyer as provided in Section 4.1(c) or as otherwise described in Section 4.1(b), Buyer shall purchase the Products at the Adjusted Price specified in Exhibit D. Other than payments expressly required under this Agreement, neither Party shall be required to make any other payments to the other Party under this Agreement, and each Party shall be solely responsible for all costs and losses incurred by it in connection with the performance of its obligations under this Agreement. In the event that the LMP in the Real-Time Energy Market or the Day-Ahead Energy Market, as applicable, for the Energy at the Delivery Point is less than \$0.00 per MWh in any hour, Seller shall credit to Buyer, on the appropriate monthly invoice, an amount equal to the product of (i) such Energy delivered in such hour and (ii) the absolute value of such hourly LMP at the Delivery Point.

5.2 **Payment and Netting.**

(a) **Billing Period.** The calendar month shall be the standard period for all charges and payments under this Agreement. On or before the fifteenth (15th) day following the end of each month, Seller shall render to Buyer an invoice for the payment obligations incurred hereunder during the preceding month, based on the Energy Delivered in the preceding month, and any RECs deposited in Buyer’s GIS account or a GIS account designated by Buyer to Seller in writing in the preceding month. Such invoice shall contain supporting detail for all charges reflected on the invoice, and Seller shall provide Buyer with additional supporting documentation and information as Buyer may request.

(b) **Timeliness of Payment.** All undisputed charges shall be due and payable in accordance with each Party’s invoice instructions on or before the later of (x) fifteen (15) days from receipt of the applicable invoice or (y) the last day of the calendar month in which the applicable invoice was received (or in either event the next Business Day if such day is not a Business Day). Each Party shall make payments by electronic funds transfer, or by other mutually agreeable method(s), to the account designated by the other Party. Any undisputed

amounts not paid by the due date shall be deemed delinquent and shall accrue interest at the Late Payment Rate, such interest to be calculated from and including the due date to but excluding the date the delinquent amount is paid in full.

(c) Disputes and Adjustments of Invoices.

- (i) All invoices rendered under this Agreement shall be subject to adjustment after the end of each month in order to true-up charges based on changes resulting from ISO-NE billing statements or revisions, if any, to previous ISO-NE billing statements. If ISO-NE resettles any invoice which relates to the Products sold under this Agreement and (a) any charges thereunder are the responsibility of the other Party under this Agreement or (b) any credits issued thereunder would be due to the other Party under this Agreement, then the Party receiving the invoice from ISO-NE shall in the case of (a) above invoice the other Party or in the case of (b) above pay the amount due to the other Party. Any invoices issued or amounts due pursuant to this Section shall be invoiced or paid as provided in this Section 5.2.
- (ii) Within twelve (12) months of the issuance of an invoice Seller shall adjust any invoice for any arithmetic or computational error and shall provide documentation and information supporting such adjustment to Buyer. Within twelve (12) months of the receipt of an invoice (or an adjusted invoice), Buyer may dispute any charges on that invoice. In the event of such a dispute, Buyer shall give notice to Seller and shall state the basis for the dispute. Payment of the disputed amount shall not be required until the dispute is resolved. Upon resolution of the dispute, any required payment or refund shall be made within ten (10) days of such resolution along with interest accrued at the Late Payment Rate from and including the due date (or in the case of a refund, the payment date) but excluding the date paid. Any claim for additional payment is waived unless Seller issues an adjusted invoice within twelve (12) months of issuance of the original invoice. Any dispute of charges is waived unless Buyer provides notice of the dispute to Seller within twelve (12) months of receipt of the invoice (or adjusted invoice) including such charges.

(d) Netting of Payments. The Parties hereby agree that they may discharge mutual debts and payment obligations due and owing to each other under this Agreement on the same date through netting of such monetary obligations, in which case all amounts owed by each Party to the other Party for the purchase and sale of Products during the monthly billing period under this Agreement, including any related damages calculated pursuant to this Agreement, interest, and payments or credits, may be netted so that only the excess amount remaining due shall be paid by the Party who owes it. If no mutual debts or payment obligations exist and only one Party owes a debt or obligation to the other during the monthly billing period, such Party

shall pay such sum in full when due. The Parties agree to provide each other with reasonable detail of such net payment or net payment request.

5.3 Interest on Late Payment or Refund. A late payment charge shall accrue on any late payment or refund as specified herein at the lesser of (a) the prime rate specified in the “Money & Investing” section of The Wall Street Journal (or, if such rate is not published therein, in a successor index mutually selected by the Parties) plus one percent (1%) , and (b) the maximum rate permitted by applicable Law in transactions involving entities having the same characteristics as the Parties (the “**Late Payment Rate**”).

5.4 Taxes, Fees and Levies.

(a) Seller shall be obligated to pay all present and future taxes, fees and levies, imposed on or associated with the Facility or Delivery or sale of the Products (“**Seller’s Taxes**”). Buyer shall be obligated to pay all present and future taxes, fees and levies, imposed on or associated with such Products after the Delivery of such Products to Buyer, or imposed on or associated with the purchase of such Products by Buyer (other than ad valorem, franchise or income taxes which are related to the sale of the Products and are, therefore, the responsibility of Seller) (“**Buyer’s Taxes**”). In the event Seller shall be required by law or regulation to remit or pay any Buyer’s Taxes, at Seller’s election, Buyer shall reimburse Seller for such payment or Seller may deduct the amount of any such Buyer’s Taxes from any amounts due to Buyer hereunder. In the event Buyer shall be required by law or regulation to remit or pay any Seller’s Taxes, at Buyer’s election, Seller shall reimburse Buyer for such payment, or Buyer may deduct the amount of any such Seller’s Taxes from the amount due to Seller under Section 5.2. Buyer shall have the right to all credits, deductions and other benefits associated with taxes paid by Buyer or reimbursed to Seller by Buyer as described herein. Nothing shall obligate or cause a Party to pay or be liable to pay any taxes, fees and levies for which it is exempt under law.

(b) Seller shall bear all risks, financial and otherwise, throughout the Term, associated with Seller’s or the Facility’s eligibility to receive any federal or state tax credits, to qualify for accelerated depreciation for Seller’s accounting, reporting or tax purposes, or to receive any other favorable tax or accounting right or benefit, or any grant or subsidy from a Governmental Entity or other Person. Seller’s obligations under this Agreement shall be effective regardless of whether the Facility is eligible for or receives, or the transactions contemplated under this Agreement are eligible for or receive, any federal or state tax credits, grants or other subsidies or any particular accounting, reporting or tax treatment.

6. SECURITY FOR PERFORMANCE

6.1 Grant of Security Interest. Subject to the terms and conditions of this Agreement, Seller hereby pledges to Buyer as security for all outstanding obligations under this Agreement (other than indemnification obligations surviving the expiration of the Term) and any other documents, instruments or agreements executed in connection therewith (collectively, the “**Obligations**”), and grants to Buyer a first priority continuing security interest, lien on, and right of set-off against all Posted Collateral delivered to or received by Buyer hereunder. Upon the return by Buyer to Seller of any Posted Collateral, the security interest and lien granted

hereunder on that Posted Collateral will be released immediately and, to the extent possible, without further action by either Party.

6.2 Seller's Support.

(a) Seller shall be required to post Credit Support with a Value of \$7,410,800 (which is equal to \$40,000.00 per MWh per hour of Contract Maximum Amount), as adjusted in accordance with Section 3.1(c), to secure Seller's Obligations until the Commercial Operation Date ("**Development Period Security**"). Fifty percent (50%) of the Development Period Security shall be provided to Buyer on the Effective Date, and the remaining fifty percent (50%) of the Development Period Security shall be provided to Buyer within fifteen (15) days after the receipt of the Regulatory Approval. Buyer shall return any undrawn amount of the Development Period Security to Seller within thirty (30) days after the earlier of (i) the termination of this Agreement pursuant to Section 8.1 and (ii) the later of (x) Buyer's receipt of an undisputed notice from Seller that the Commercial Operation Date has occurred or (y) Buyer's receipt of the full amount of the Operating Period Security.

(b) Beginning not later than three (3) days following the Commercial Operation Date, Seller shall provide Buyer with Credit Support to secure Seller's Obligations after the Commercial Operation Date through and including the date that all of Seller's Obligations are satisfied ("**Operating Period Security**"). The Operating Period Security shall have a Value of \$7,410,800 (which is equal to \$40,000.00 per MWh per hour of Contract Maximum Amount), as adjusted in accordance with Section 3.3(b) and Section 3.3(c). Neither the Development Period Security nor the Operating Period Security includes any Default Credit Support, and the unused portion (if any) of such Default Credit Support will be returned to Seller within thirty (30) days after the earlier of (i) the cure of the related Default, (ii) the expiration of the Term or (iii) termination of this Agreement under Section 9.3(b) or Section 10.1(c). The Operating Period Security also does not include the Credit Support provided under Section 3.4(b)(xv), which Credit Support will be returned to Seller upon the achievement of the "Commercial Operation Date" under the Phase II Mayflower Wind Power Purchase Agreement.

(c) The Credit Support Delivery Amount, as defined below, will be rounded up, and the Credit Support Return Amount, as defined below, will be rounded down, in each case to the nearest integral multiple of \$10,000 ("**Rounding Amount**").

(d) The following items will qualify as "**Credit Support**" hereunder in the amount noted under "Valuation Percentage":

		<u>"Valuation Percentage"</u>
(A)	Cash	100%
(B)	Letters of Credit	100% unless either (i) a Letter of Credit Event shall have occurred and be continuing with respect to such Letter of Credit, or (ii) twenty (20) or fewer Business Days remain prior to the expiration of such Letter of Credit, in

which cases the Valuation Percentage shall be 0%.

(e) All calculations with respect to Credit Support shall be made by the Valuation Agent as of the close of business on the Business Day before the Valuation Date.

6.3 Delivery of Credit Support.

On any Business Day during the Services Term on which (a) no Event of Default has occurred and is continuing with respect to Buyer, and (b) no termination date has occurred or has been designated as a result of an Event of Default with respect to Buyer for which there exist any unsatisfied payment obligations with respect to Buyer, then Buyer may request, by written notice, that Seller Transfer to Buyer, or cause to be Transferred to Buyer, Credit Support for the benefit of Buyer, to the extent the Collateral Requirement exceeds the Value of the Posted Collateral posted by Seller (“**Credit Support Delivery Amount**”). Such Credit Support shall be delivered to Buyer on the next Business Day if such request is received by 5:00 p.m. Eastern Prevailing Time on a Business Day; otherwise Credit Support is due by the close of business on the second Business Day after the request is received.

6.4 Reduction and Substitution of Posted Collateral.

On any Business Day during the Services Term on which (a) no Event of Default has occurred and is continuing with respect to Seller, (b) no termination date has occurred or has been designated as a result of an Event of Default with respect to Seller for which there exist any unsatisfied payment Obligations, and (c) the Posted Collateral posted by Seller exceeds the sum of the required Operating Period Security and any required Default Credit Support (rounding downwards for any fractional amount to the next interval of the Rounding Amount), then Seller may, at its sole cost, request that Buyer return Operating Period Security or Default Credit Support, as applicable, in the amount of such difference (“**Credit Support Return Amount**”) and Buyer shall be obligated to do so. Such Posted Collateral shall be returned to Seller by the close of business on the second Business Day after Buyer’s receipt of such request. The Parties agree that if Seller has posted more than one type of Credit Support to Buyer, Seller can, in its sole discretion, select the type of Credit Support for Buyer to return; provided, however, that Buyer shall not be required to return the specified Credit Support if immediately after such return, Seller would be required to post additional Credit Support pursuant to the calculation of Operating Period Security or Default Credit Support.

6.5 Administration of Posted Collateral.

(a) Cash. Posted Collateral provided in the form of Cash to Buyer hereunder shall be subject to the following provisions.

- (i) So long as no Event of Default has occurred and is continuing with respect to Buyer, Buyer will be entitled to either hold Cash or to appoint an agent which is a Qualified Institution (a “**Custodian**”) to hold Cash for Buyer. In the event that an Event of Default has occurred and is continuing with respect to Buyer, then Buyer will not be entitled to hold Cash and the provisions of Section 6.5(a)(ii)

shall not apply with respect to Buyer, and Cash shall be held in a Qualified Institution in accordance with the provisions of Section 6.5(a)(iii)(B). Upon notice by Buyer to Seller of the appointment of a Custodian, Seller's Obligations to make any Transfer will be discharged by making the Transfer to that Custodian. The holding of Cash by a Custodian will be deemed to be the holding of Cash by Buyer for which the Custodian is acting. If Buyer or its Custodian fails to satisfy any conditions for holding Cash as set forth above, or if Buyer is not entitled to hold Cash at any time, then Buyer will Transfer, or cause its Custodian to Transfer, the Cash to a Qualified Institution and the Cash shall be maintained in accordance with Section 6.5(a)(iii)(B). Buyer will be liable for the acts or omissions of the Custodian to the same extent that Buyer would be held liable for its own acts or omissions.

- (ii) If no Event of Default has occurred and is continuing with respect to Buyer and no termination date has occurred or been designated as a result of an Event of Default with respect to Buyer for which there exists any unsatisfied payment obligations with respect to Buyer, then Buyer shall have the right to sell, pledge, rehypothecate, assign, invest, use, comingle or otherwise use in its business any Cash that it holds as Posted Collateral hereunder, subject to Buyer's obligations under this Article 6.
- (iii) If neither Buyer nor the Custodian is eligible to hold Cash pursuant to Section 6.5(a)(i) then:
 - (A) the provisions of Section 6.5(a)(ii) will not apply with respect to Buyer; and
 - (B) Buyer shall be required to Transfer (or cause to be Transferred) not later than the close of business within five (5) Business Days following the beginning of such ineligibility all Cash in its possession or held on its behalf to a Qualified Institution to be held in a segregated, safekeeping or custody account (the "**Collateral Account**") within such Qualified Institution with the title of the account indicating that the property contained therein is being held as Cash for Buyer. The Qualified Institution shall serve as Custodian with respect to the Cash in the Collateral Account, and shall hold such Cash in accordance with the terms of this Article 6 and for the security interest of Buyer and execute such account control agreements as are necessary or applicable to perfect the security interest of Buyer therein pursuant to Section 9-314 of the Uniform Commercial Code or otherwise, and subject to such security interest, for the ownership and benefit of Seller.

The Qualified Institution holding the Cash will invest and reinvest or procure the investment and reinvestment of the Cash in accordance with the written instructions of Buyer, subject to the approval of such instructions by Seller (which approval shall not be unreasonably withheld). Buyer shall have no responsibility for any losses resulting from any investment or reinvestment effected in accordance with Seller's approval.

- (iv) So long as no Event of Default with respect to Seller has occurred and is continuing, and no termination date has occurred or been designated for which any unsatisfied payment obligations of Seller exist as the result of an Event of Default with respect to Seller, in the event that Buyer or its Custodian is holding Cash, Buyer will Transfer (or cause to be Transferred) to Seller, in lieu of any interest or other amounts paid or deemed to have been paid with respect to such Cash (all of which shall be retained by Buyer), the Interest Amount. Interest on Cash shall accrue at the Collateral Interest Rate. Interest accrued during the previous month shall be paid by Buyer to Seller on the 3rd Business Day of each calendar month and on any Business Day that posted Credit Support in the form of Cash is returned to Seller, but solely to the extent that, after making such payment, the amount of the Posted Collateral will be at least equal to the required Development Period Security or Operating Period Security, as applicable, plus any required Default Credit Support. On or after the occurrence of an Event of Default with respect to Seller or a termination date as a result of an Event of Default with respect to Seller, Buyer or its Custodian shall retain any such Interest Amount as additional Posted Collateral hereunder until the Obligations of Seller under the Agreement have been satisfied in the case of a termination date or for so long as such Event of Default is continuing in the case of an Event of Default.

(b) Buyer's Rights and Remedies. If at any time an Event of Default with respect to Seller has occurred and is continuing, then, unless Seller has paid in full all of its Obligations that are then due, including those under Section 9.3(b) of this Agreement, Buyer may exercise one or more of the following rights and remedies: (i) all rights and remedies available to a secured party under applicable Law with respect to Posted Collateral held by Buyer, (ii) the right to set-off any amounts payable by Seller with respect to any Obligations against any Posted Collateral or the cash equivalent of any Posted Collateral held by Buyer, or (iii) the right to liquidate any Posted Collateral held by Buyer and to apply the proceeds of such liquidation of the Posted Collateral to any amounts payable to Buyer with respect to the Obligations in such order as Buyer may elect. For purposes of this Section 6.5, Buyer may draw on the undrawn portion of any Letter of Credit from time to time up to the amount of the Obligations that are due at the time of such drawing. Cash proceeds that are not applied to the Obligations shall be maintained in accordance with the terms of this Article 6. Seller shall

remain liable for amounts due and owing to Buyer that remain unpaid after the application of Posted Collateral, pursuant to this Section 6.5.

(c) Letters of Credit. Credit Support provided in the form of a Letter of Credit shall be subject to the following provisions.

- (i) As one method of providing increased Credit Support, Seller may increase the amount of an outstanding Letter of Credit or establish one or more additional Letters of Credit.
- (ii) Upon the occurrence of a Letter of Credit Event, Seller agrees to Transfer to Buyer either a substitute Letter of Credit or Cash, in each case on or before the first (1st) Business Day after the occurrence thereof (or the third (3rd) Business Day after the occurrence thereof if only clause (a) of the definition of Letter of Credit Event applies).
- (iii) Notwithstanding Sections 6.3 and 6.4, (1) Buyer need not return a Letter of Credit unless the entire principal amount is required to be returned, (2) Buyer shall consent to a reduction of the principal amount of a Letter of Credit to the extent that a Credit Support Delivery Amount would not be created thereby (as of the time of the request or as of the last time the Credit Support Delivery Amount was determined), and (3) if there is more than one form of Posted Collateral when a Credit Support Return Amount is to be Transferred, Buyer may elect which to Transfer.

(d) Care of Posted Collateral. Buyer shall exercise reasonable care to assure the safe custody of all Posted Collateral to the extent required by applicable Law, and in any event Buyer will be deemed to have exercised reasonable care if it exercises at least the same degree of care as it would exercise with respect to its own property. Except as specified in this Article 6, Buyer will have no duty with respect to the Posted Collateral, including without limitation, any duty to enforce or preserve any rights thereto.

(e) Substitutions. Unless otherwise prohibited herein, upon notice to Buyer specifying the items of Posted Collateral to be exchanged, Seller may, on any Business Day, deliver to Buyer other Credit Support (“**Substitute Credit Support**”). On the Business Day following the day on which the Substitute Credit Support is delivered to Buyer, Buyer shall return to Seller the items of Credit Support specified in Seller’s notice; provided, however, that Buyer shall not be required to return the specified Posted Collateral if immediately after such return, Seller would be required to post additional Credit Support pursuant to the calculation of Development Period Security or Operating Period Security set forth in Sections 6.2(a) and 6.2(b), respectively.

6.6 Exercise of Rights Against Posted Collateral

(a) Disputes Regarding Amount of Credit Support. If either Party disputes the amount of Credit Support to be provided or returned (such Party the “**Disputing Party**”), then the Disputing Party shall (a) deliver the undisputed amount of Credit Support to the other Party (such Party, the “**Requesting Party**”) and (b) notify the Requesting Party of the existence and nature of the dispute no later than 5:00 p.m. Eastern Prevailing Time on the Business Day that the request for Credit Support was made (the “**Request Date**”). On the Business Day following the Request Date, the Parties shall consult with each other in order to reconcile the two conflicting amounts. If the Parties are not able to resolve their dispute, the Credit Support shall be recalculated, on the Business Day following the Request Date, by each Party requesting quotations from two (2) Reference Market-Makers for a total of four (4) quotations. The highest and lowest of the four (4) quotations shall be discarded and the arithmetic average shall be taken of the remaining two (2), which shall be used in order to determine the amount of Credit Support required. On the same day the Credit Support amount is recalculated, the Disputing Party shall deliver any additional Credit Support required pursuant to the recalculation or the Requesting Party shall return any excess Credit Support that is no longer required pursuant to the recalculation.

(b) Further Assurances. Promptly following a request by a Party, the other Party shall use commercially reasonable efforts to execute, deliver, file, and/or record any financing statement, specific assignment, or other document and take any other action that may be necessary or desirable to create, perfect, or validate any Posted Collateral or other security interest or lien, to enable the requesting party to exercise or enforce its rights or remedies under this Agreement, or with respect to Posted Collateral, or accrued interest.

(c) Further Protection. Seller will promptly give notice to Buyer of, and defend against, any suit, action, proceeding, or lien (other than a banker’s lien in favor of the Custodian appointed by Buyer, so long as no amount owing from Seller to such Custodian is overdue, or other liens created by or through Buyer) that involves the Posted Collateral delivered to Buyer by Seller or that could adversely affect any security interest or lien granted pursuant to this Agreement.

6.7 Return of Credit Support. Any Credit Support with respect to Operating Period Security or Default Credit Support provided under this Agreement that is unused at the time of the expiration or termination of this Agreement shall be returned to Seller only after any such Credit Support has been used to satisfy any outstanding Obligations of Seller in existence at such time. Provided such Obligations have been satisfied, such Credit Support with respect to Operating Period Security or Default Credit Support shall be returned to Seller within thirty (30) days after the earlier of (a) the expiration of the Term or (b) termination of this Agreement under Article 8, Section 9.3(b) or Section 10.1(c).

7. **REPRESENTATIONS, WARRANTIES, COVENANTS AND ACKNOWLEDGEMENTS**

7.1 Representations and Warranties of Buyer. Buyer hereby represents and warrants to Seller as follows:

(a) Organization and Good Standing; Power and Authority. Buyer is a corporation duly incorporated, validly existing and in good standing under the laws of the Commonwealth of Massachusetts. Subject to the receipt of the Regulatory Approval, Buyer has all requisite power and authority to execute, deliver, and perform its obligations under this Agreement.

(b) Due Authorization; No Conflicts. The execution and delivery by Buyer of this Agreement, and the performance by Buyer of its obligations hereunder, have been duly authorized by all necessary actions on the part of Buyer and do not and, under existing facts and Law, shall not: (i) contravene its certificate of incorporation or any other governing documents; (ii) conflict with, result in a breach of, or constitute a default under any note, bond, mortgage, indenture, deed of trust, license, contract or other agreement to which it is a party or by which any of its properties may be bound or affected; (iii) subject to receipt of the Regulatory Approval, violate any order, writ, injunction, decree, judgment, award, statute, law, rule, regulation or ordinance of any Governmental Entity or agency applicable to it or any of its properties; or (iv) result in the creation of any lien, charge or encumbrance upon any of its properties pursuant to any of the foregoing.

(c) Binding Agreement. This Agreement has been duly executed and delivered on behalf of Buyer and, assuming the due execution hereof and performance hereunder by Seller and receipt of the Regulatory Approval, constitutes a legal, valid and binding obligation of Buyer, enforceable against it in accordance with its terms, except as such enforceability may be limited by law or principles of equity.

(d) No Proceedings. As of the Effective Date, except to the extent relating to the Regulatory Approval, there are no actions, suits or other proceedings, at law or in equity, by or before any Governmental Entity or agency or any other body pending or, to the best of its knowledge, threatened against or affecting Buyer or any of its properties (including, without limitation, this Agreement) which relate in any manner to this Agreement or any transaction contemplated hereby, or which Buyer reasonably expects to lead to a material adverse effect on (i) the validity or enforceability of this Agreement or (ii) Buyer's ability to perform its obligations under this Agreement.

(e) Consents and Approvals. Except to the extent associated with the Regulatory Approval, the execution, delivery and performance by Buyer of its obligations under this Agreement do not and, under existing facts and Law, shall not, require any Permit or any other action by, any Person which has not been duly obtained, made or taken or that shall be duly obtained, made or taken on or prior to the date required, and all such approvals, consents, permits, licenses, authorizations, filings, registrations and actions are in full force and effect, final and non-appealable as required under applicable Law.

(f) Negotiations. The terms and provisions of this Agreement are the result of arm's length and good faith negotiations on the part of Buyer and equal bargaining power of the Parties. No principle of law or equity regarding construing ambiguities in this Agreement against the drafting Party shall apply.

(g) Bankruptcy. There are no bankruptcy, insolvency, reorganization, receivership or other such proceedings pending against or being contemplated by Buyer, or, to Buyer's knowledge, threatened against it.

(h) No Default. No Default or Event of Default has occurred and is continuing and no Default or Event of Default shall occur as a result of the performance by Buyer of its obligations under this Agreement.

7.2 Representations and Warranties of Seller. Seller hereby represents and warrants to Buyer as of the Effective Date as follows:

(a) Organization and Good Standing; Power and Authority. Seller is a limited liability company, duly formed, validly existing and in good standing under the laws of Delaware. Subject to the receipt of the Permits listed in Exhibit B and any Related Transmission Approvals, Seller has all requisite power and authority to execute, deliver, and perform its obligations under this Agreement.

(b) Authority. Seller (i) has the power and authority to own and operate its businesses and properties, to own or lease the property it occupies and to conduct the business in which it is currently engaged; (ii) is duly qualified and in good standing under the laws of each jurisdiction where its ownership, lease or operation of property or the conduct of its business requires such qualification; and (iii) holds, or shall hold as and when required to perform its obligations under this Agreement, all rights and entitlements (other than Permits or real property rights for which the applicable Critical Milestone deadline has not yet passed) necessary to construct, own and operate the Facility and to deliver the Products to Buyer in accordance with this Agreement.

(c) Due Authorization; No Conflicts. The execution and delivery by Seller of this Agreement, and the performance by Seller of its obligations hereunder, have been duly authorized by all necessary actions on the part of Seller and do not and, under existing facts and Law, shall not: (i) contravene any of its governing documents; (ii) conflict with, result in a breach of, or constitute a default under any note, bond, mortgage, indenture, deed of trust, license, contract or other agreement to which it is a party or by which any of its properties may be bound or affected; (iii) assuming receipt of the Permits listed on Exhibit B and any Related Transmission Approvals, violate any order, writ, injunction, decree, judgment, award, statute, law, rule, regulation or ordinance of any Governmental Entity or agency applicable to it or any of its properties; or (iv) result in the creation of any lien, charge or encumbrance upon any of its properties pursuant to any of the foregoing. As of the date when Seller applies for FCAQ under Section 3.7 and as of the Commercial Operation Date, Seller shall be qualified to perform as a Market Participant under the ISO-NE Tariff, or shall be qualified to transact through another Market Participant under the ISO-NE Tariff. As of the Effective Date and as of the Commercial Operation Date, Seller will not be disqualified from or be materially adversely affected in the performance of any of its obligations under this Agreement by reason of market power or affiliate transaction issues under federal or state regulatory requirements.

(d) Binding Agreement. This Agreement has been duly executed and delivered on behalf of Seller and, assuming the due execution hereof and performance hereunder

REDACTED

by Buyer and receipt of the Permits listed on Exhibit B and any Related Transmission Approvals, constitutes a legal, valid and binding obligation of Seller, enforceable against it in accordance with its terms, except as such enforceability may be limited by law or principles of equity.

(e) No Proceedings. Except to the extent associated with the Regulatory Approval and the Permits listed on Exhibit B and any Related Transmission Approvals, (x) as of the Effective Date, there are no actions, suits or other proceedings, at law or in equity, by or before any Governmental Entity or agency or any other body pending or, to the best of its knowledge, threatened against or affecting Seller or any of its properties (including, without limitation, this Agreement) which relate in any manner to this Agreement or any transaction contemplated hereby and that could reasonably be expected to have a material adverse effect on (i) the validity or enforceability of this Agreement or (ii) Seller's ability to perform its obligations under this Agreement, and (y) after the Effective Date, there are no actions, suits or other proceedings, at law or in equity, by or before any Governmental Entity or agency or any other body pending or, to the best of its knowledge, threatened against or affecting Seller or any of its properties (including, without limitation, this Agreement) which relate in any manner to this Agreement or any transaction contemplated hereby and that, upon final resolution and expiration of all applicable appeal periods, has a material adverse effect on (i) the validity or enforceability of this Agreement or (ii) Seller's ability to perform its obligations under this Agreement. In the event that any such action, suit or proceeding is commenced or threatened after the Effective Date that, if determined adversely to Seller, could reasonably be expected to result in a breach of this Section 7.2(e), Seller will provide notice thereof to Buyer promptly upon Seller obtaining actual knowledge thereof.

(f) Consents and Approvals. As of the Effective Date and subject to the receipt of the Permits listed on Exhibit B on or prior to the date such Permits are required under applicable Law and subject to the receipt of (i) the Related Transmission Approvals on or prior to the date such Related Transmission Approvals are required under applicable Law, and (ii) the Regulatory Approval on or prior to the date the Regulatory Approval is required under applicable Law, the execution, delivery and performance by Seller of its obligations under this Agreement do not and, under existing facts and Law, shall not, require any Permit or any other action by, any Person which has not been duly obtained, made or taken, and all such approvals, consents, permits, licenses, authorizations, filings, registrations and actions are in full force and effect, final and non-appealable. To Seller's knowledge, Seller shall be able to receive the Permits listed in Exhibit B and the Related Transmission Approvals in due course and as required under applicable Law to the extent that those Permits or Related Transmission Approvals have not previously been received.

(g) RPS Class I Renewable Generation Unit, etc. The Facility shall be (i) a RPS Class I Renewable Generation Unit, qualified by the DOER as eligible to participate in the RPS program, under Section 11F of Chapter 25A (subject to Section 4.1(c) in the event of a change in Law affecting such qualification as a RPS Class I Renewable Generation Unit), (ii) a Clean Peak Resource eligible under the Clean Peak Standard (subject to Sections 4.1(b) and 4.1(c) in the event of a change in Law affecting such qualification as a Clean Peak Resource) and (iii) tracked in the GIS to ensure a unit-specific accounting of the Delivery of the Energy to enable the Massachusetts Department of Environmental Protection to accurately account for such

Energy in the state greenhouse gas emissions inventory, created under chapter 298 of the Acts of 2008, and the Facility shall have a Commercial Operation Date as verified by Buyer.

(h) Title to Products. Seller has and shall have good and marketable title to all Products sold and Delivered to Buyer under this Agreement, free and clear of all liens, charges and encumbrances at the time of Delivery hereunder. Seller has not sold and, except as permitted in accordance with the terms of this Agreement, shall not sell any such Products to any other Person, and no Person other than Seller can claim an interest in any Product to be sold to Buyer under this Agreement.

(i) Negotiations. The terms and provisions of this Agreement are the result of arm's length and good faith negotiations on the part of Seller and equal bargaining power of the Parties. No principle of law or equity regarding construing ambiguities in this Agreement against the drafting Party shall apply.

(j) Bankruptcy. There are no bankruptcy, insolvency, reorganization, receivership or other such proceedings pending against or being contemplated by Seller, or, to Seller's knowledge, threatened against it.

(k) No Misrepresentations. No factual information contained in the written reports or other written submittals furnished by or on behalf of Seller to Buyer under this Agreement, when taken as a whole, contain as of the date furnished any untrue statement of a material fact, or omit to state any material fact necessary to make the statements contained therein not misleading as of the date furnished; provided, however, that (i) no representation or warranty is made with respect to any projections or other forward-looking statement furnished by or on behalf of Seller to Buyer under this Agreement and (ii) to the extent any written reports or other written submittals are based on information provided by a Person other than Seller or its Affiliates, the preceding representation and warranty is limited to the knowledge of Seller.

(l) No Default. No Default or Event of Default has occurred and is continuing and no Default or Event of Default shall occur as a result of the performance by Seller of its obligations under this Agreement.

(m) Site Control. As of the Effective Date, Seller holds a federal lease issued on a competitive basis after January 1, 2012 for an offshore wind energy generation site located on the Outer Continental Shelf and for which no turbine is located within ten miles of any inhabited area; and, as of the date set forth in 3.1(a)(i) for such Critical Milestone (as extended pursuant to Sections 3.1(c), 3.1(e), and 10.1), Seller will have acquired all other real property rights to construct and operate the Facility, to interconnect the Facility to the Interconnecting Utility, to construct the Network Upgrades (to the extent it is Seller's responsibility to do so) and to perform Seller's obligations under this Agreement.

(n) Commitment Agreement. As of the Effective Date, Seller has executed the Commitment Agreement and the Commitment Agreement is in full force and effect.

7.3 Continuing Nature of Representations and Warranties. The representations and warranties set forth in this Section are made as of the Effective Date and, except where otherwise

stated, deemed made continually throughout the Term, subject to the removal of the references to the Regulatory Approval and Permits as and when the Regulatory Approval and Permits are obtained. If at any time during the Term, a Party has knowledge of any event or information which causes any of the representations and warranties in this Article 7 to be untrue or misleading, such Party shall provide the other Party with prompt written notice of the event or information, the representations and warranties affected, and the corrective action such Party shall take. The notice required pursuant to this Section shall be given as soon as practicable after the occurrence of each such event. A breach of or default under the Commitment Agreement after the Effective Date will not operate to create an Event of Default under this Agreement, unless the conduct producing the breach of or default under the Commitment Agreement would independently create an Event of Default under this Agreement.

8. REGULATORY APPROVAL

8.1 Receipt of Regulatory Approval. The obligations of the Parties to perform this Agreement, other than the Parties' obligations under Section 3.3(d), Section 3.7, Section 6.1, Section 6.2, this Section 8.1, Section 11 and Section 12, are conditioned upon and shall not become effective or binding until the receipt of the Regulatory Approval. Buyer shall file for the Regulatory Approval and will use commercially reasonable efforts to make that filing within ninety (90) days after the Effective Date. Buyer shall notify Seller within ten (10) Business Days after receipt of the Regulatory Approval or receipt of a final written order of the MDPU regarding this Agreement that does not satisfy all of the requirements of the Regulatory Approval (except that the final written order may remain subject to appeal or rehearing). This Agreement may be terminated by either Buyer or Seller in the event that Regulatory Approval is not received within two hundred seventy (270) days after filing, without liability as a result of such termination, subject to the return of Credit Support as provided in Section 6.2.

9. BREACHES; REMEDIES

9.1 Events of Default by Either Party. Each of the following shall constitute an event of default ("**Event of Default**") by either Party hereunder:

(a) Representation or Warranty. Any breach of any representation or warranty of such Party set forth herein, or in filings or reports made pursuant to this Agreement occurs, where such breach is not fully cured and corrected within thirty (30) days after the Non-Defaulting Party has provided written notice to the Defaulting Party; provided, however, such period shall be extended for an additional period of up to sixty (60) days in the case of any breach of any representation or warranty set forth in Sections 7.1(e), 7.1(f), 7.1(g), 7.2(b)(iii), 7.2(f), 7.2(g), 7.2(h), 7.2(i), 7.2(j), 7.2(k) and 7.2(l) or thirty (30) days in the case of breach of any other representation or warranty, in each case, if, despite using commercially reasonable efforts, the Defaulting Party is unable to cure within the initial thirty (30) day period so long as such cure is diligently pursued by the Defaulting Party until such Default had been corrected, but in any event shall be cured within sixty (60) or ninety (90) days, as applicable, after the notice from the Non-Defaulting Party; or

(b) Payment Obligations. Any undisputed payment due and payable hereunder is not made on the date due, and such failure continues for more than ten (10)

Business Days after notice thereof is given by the Non-Defaulting Party to the Defaulting Party;
or

- (c) Other Covenants. Other than:
 - (i) failure of the Facility to achieve the Commercial Operation Date by the Guaranteed Commercial Operation Date;
 - (ii) a Rejected Purchase; or
 - (iii) an Event of Default described in Section 9.1(a), 9.1(b), 9.1(d), 9.1(e) or 9.2,

such Party fails to perform, observe or otherwise to comply with any obligation hereunder and such failure continues for more than thirty (30) days after notice thereof is given by the Non-Defaulting Party to the Defaulting Party; provided, however, such period shall be extended for an additional period of up to thirty (30) days if, despite using commercially reasonable efforts, the Defaulting Party is unable to cure within the initial thirty (30) day period so long as such cure is diligently pursued by the Defaulting Party until such Default had been corrected, but in any event shall be cured within sixty (60) days of the notice from the Non-Defaulting Party; or

(d) Bankruptcy. Such Party (i) is adjudged bankrupt or files a petition in voluntary bankruptcy under any provision of any bankruptcy law or consents to the filing of any bankruptcy or reorganization petition against such Party under any such law, or (without limiting the generality of the foregoing) files a petition to reorganize pursuant to 11 U.S.C. § 101 *et seq.* or any similar statute applicable to such Party, as now or hereinafter in effect, (ii) makes an assignment for the benefit of creditors, or admits in writing an inability to pay its debts generally as they become due, or consents to the appointment of a receiver or liquidator or trustee or assignee in bankruptcy or insolvency of such Party, or (iii) is subject to an order of a court of competent jurisdiction appointing a receiver or liquidator or custodian or trustee of such Party or of a major part of such Party's property, which is not dismissed within sixty (60) days; or

(e) Permit Compliance. Such Party fails to obtain and maintain or cause to be obtained and maintained in full force and effect any Permit (other than the Regulatory Approval) necessary for such Party to perform its obligations under this Agreement ("**Permit Failure**") and such Permit Failure continues for more than thirty (30) days after the Defaulting Party's actual knowledge thereof; provided, however, that, if a Party has more than three (3) Permit Failures during the Term, then such Party shall no longer have the benefit of any cure period.

9.2 Events of Default by Seller. In addition to the Events of Default described in Section 9.1, each of the following shall constitute an Event of Default by Seller hereunder:

(a) Taking of Facility Assets. Other than with respect to a foreclosure on or other exercise by any Lender of any rights and remedy with respect to any asset of Seller in connection with a Financing, any asset of Seller that is required for the construction, operation or maintenance of the Facility or the performance of its obligations hereunder is taken upon execution or by other process of law directed against Seller, or any such asset is taken upon or

subject to any attachment by any creditor of or claimant against Seller and such attachment is not disposed of within sixty (60) days after such attachment is levied; or

(b) Failure to Maintain Credit Support. The failure of Seller to provide, maintain and/or replenish the Development Period Security, the Operating Period Security or the Default Credit Support as required pursuant to this Agreement (including without limitation upon any Letter of Credit Event), and such failure continues for more than five (5) Business Days after Buyer has provided written notice thereof to Seller; or

(c) Energy Output. The failure of the Facility to produce any Energy for twelve (12) consecutive months during the Services Term, except to the extent excused by (i) a Force Majeure, (ii) a Catastrophic Failure not caused by a Force Majeure, unless and until such Catastrophic Failure exceeds the duration of the Catastrophic Failure Period, or (iii) if the applicable LMP at the Delivery Point is negative (as described in Section 4.2(a)) for the entire twelve (12) month period; or

(d) Failure to Satisfy ISO-NE Obligations. The failure of Seller to satisfy, or cause to be satisfied (other than by Buyer), any material obligation of Seller under the ISO-NE Rules or ISO-NE Practices or any other material obligation of Seller with respect to ISO-NE where such failure has an adverse effect on the Facility or Seller's ability to perform its obligations under this Agreement or on Buyer or Buyer's rights or ability to receive the benefits under this Agreement and such failure is not cured within five (5) days after the earlier of (1) the date on which ISO-NE notifies Seller of such failure in writing, or (2) the date on which Seller obtains, or should reasonably have obtained, knowledge of such failure; provided, however,

[REDACTED]

or

(e) Failure to Meet Critical Milestones. The failure of Seller to satisfy any Critical Milestone by the date set forth therefor in Section 3.1(a), as the same may be extended in accordance with Sections 3.1(c), 3.1(d), 3.1(e), 3.2 and 10.1; or

(f) Abandonment. On or after the Commercial Operation Date, the permanent relinquishment by Seller of all of its possession and control of the Facility, other than a transfer permitted under this Agreement; or

(g) Assignment. The assignment of this Agreement by Seller, or Seller's sale or transfer of its interest (or any part thereof) in the Facility, except as permitted in accordance with Article 14; or

(h) Delivery Failure. Either (i) the occurrence of a Delivery Failure on eleven (11) or more calendar days during the Services Term that that are not cured through a corrective Internal Bilateral Transaction and transfer in the GIS as described in Section 4.3 (and that is not the subject of a good faith dispute pursuant to Article 11 of this Agreement, and that are not

otherwise described in clause (ii) of this Section 9.2(h)), or (ii) any single Delivery Failure which Seller has failed to take commercially reasonable efforts to cure through a corrective Internal Bilateral Transaction and transfer in the GIS as described in Section 4.3 after Buyer has requested such a cure in writing (and that is not the subject of a good faith dispute pursuant to Article 11 of this Agreement); or

(i) Failure to Provide Status Reports. A failure to provide timely, accurate and complete status reports in accordance with this Agreement, and such failure continues for more than five (5) days after notice thereof is given by Buyer; or

(j) Failure to Maintain RPS Eligibility. [REDACTED]

[REDACTED]

; or

(k) Failure to Maintain CES Eligibility. [REDACTED]

[REDACTED]

; or

(l) Failure to Maintain Clean Peak Standard Eligibility. [REDACTED]

[REDACTED]

[REDACTED] or

(m) Biennial Average Real-Time High Operating Limit Deficiency. A failure of the Biennial Average Real-Time High Operating Limit for any two consecutive Contract Years to be at least fifty percent (50%) of the Actual Facility Size, except to the extent excused by (i) a Force Majeure (without affecting Buyer’s right to terminate this Agreement under Section 10.1(c)), (ii) a Catastrophic Failure not caused by a Force Majeure, unless and until such Catastrophic Failure exceeds the duration of the Catastrophic Failure Period or (iii) a Reliability Curtailment.

9.3 Remedies.

(a) Suspension of Performance and Remedies at Law. Upon the occurrence and during the continuance of an Event of Default, the Non-Defaulting Party shall have the right, but not the obligation, to (i) withhold any payments due the Defaulting Party under this Agreement, (ii) suspend its performance hereunder, and (iii) exercise such other remedies as provided for in this Agreement including, without limitation, the termination right set forth in Section 9.3(b), and, to the extent not inconsistent with the terms of this Agreement, such remedies available at law and in equity. In addition to the foregoing, except for breaches for which an express remedy or measure of damages is provided herein, the Non-Defaulting Party shall retain its right of specific performance to enforce the Defaulting Party’s obligations under this Agreement.

(b) Termination and Termination Payment. Upon the occurrence of an Event of Default, a Non-Defaulting Party may terminate this Agreement at its sole discretion by providing written notice of such termination to the Defaulting Party. If the Non-Defaulting Party terminates this Agreement, it shall be entitled to calculate and receive as its sole remedy for such Event of Default a “Termination Payment” as follows:

(i) *Termination by Buyer Prior to Commercial Operation Date*. If Buyer terminates this Agreement because of an Event of Default by Seller occurring prior to the Commercial Operation Date, the Termination Payment due to Buyer shall be equal to the sum of (x) all Delay Damages due and owing by Seller through the date of such termination plus (y) the full amount of the Development Period Security required to be provided to Buyer by Seller.

(ii) *Termination by Seller Prior to Commercial Operation Date*. [REDACTED]



- (iii) *Termination by Buyer On or After Commercial Operation Date.* If Buyer terminates this Agreement because of an Event of Default by Seller occurring on or after the Commercial Operation Date, the Termination Payment due to Buyer shall be equal to the greater of: (i) the security required to be provided in accordance with Article 6, and (ii) the amount, if positive, calculated according to the following formula: (x) the present value, discounted at a rate equal to the prime rate specified in the “Money & Investing” section of *The Wall Street Journal* determined as of the date of the notice of default, plus 300 basis points, for each month remaining in the Services Term, of (A) the amount, if, any, by which the forward market price of Energy and RECs, as determined by the average of the quotes of at least two nationally recognized energy consulting firms or brokers chosen by Buyer, for Replacement Energy and Replacement RECs, exceeds the applicable Price that would have been paid pursuant to Exhibit D of this Agreement, multiplied by (B) Buyer’s Percentage Entitlement of the projected Energy output of the Facility as determined by a recognized third party expert selected by Buyer, using a probability of exceedance basis of 50%; plus (y) any costs and losses incurred by Buyer as a result of the Event of Default and termination of the Agreement.

- (iv) *Termination by Seller On or After Commercial Operation Date.* If Seller terminates this Agreement because of an Event of Default by Buyer occurring on or after the Commercial Operation Date, the Termination Payment due to Seller shall be equal to the amount, if positive, calculated according to the following formula: (x) the present value, discounted at a rate equal to the prime rate specified in the “Money & Investing” section of *The Wall Street Journal* determined as of the date of the notice of default, plus 300 basis points, for each month remaining in the Services Term, of (i) the amount, if, any, by which the applicable Price that would have been paid pursuant to Exhibit D of this Agreement, exceeds the forward market price of Energy and RECs as determined by the average of the quotes of at least two nationally recognized energy consulting firms or brokers chosen by Seller, for Replacement Energy and Replacement RECs, multiplied by (ii) Buyer’s Percentage Entitlement to the projected Energy output of the

Facility as determined by a recognized third party expert selected by Seller using a probability of exceedance basis of 50%; plus, (y) any costs and losses incurred by Seller as a result of the Event of Default and termination of the Agreement.

- (v) *Acceptability of Liquidated Damages.* Each Party agrees and acknowledges that (i) the damages and losses (including without limitation the loss of environmental, reliability and economic benefits contemplated under this Agreement) that the Parties would incur due to an Event of Default would be difficult or impossible to predict with certainty, and (ii) it is impractical and difficult to assess actual damages in the circumstances stated, and therefore the Termination Payment as agreed to by the Parties and set forth herein is a fair and reasonable calculation of such damages.
- (vi) *Payment of Termination Payment.* The Defaulting Party shall make the Termination Payment within ten (10) Business Days after such notice is effective, regardless whether the Termination Payment calculation is disputed. If the Defaulting Party disputes the Non-Defaulting Party's calculation of the Termination Payment, in whole or in part, the Defaulting Party shall within ten (10) Business Days of receipt of the calculation of the Termination Payment, provide to the Non-Defaulting Party a detailed written explanation of the basis for such dispute. If the Parties are unable to resolve the dispute within thirty (30) days, Article 11 shall apply.

(c) Set-off. The Non-Defaulting Party shall be entitled, at its option and in its discretion, to withhold and set off any amounts owed by the Non-Defaulting Party to the Defaulting Party against any payments and any other amounts owed by the Defaulting Party to the Non-Defaulting Party, including any Termination Payment payable as a result of any early termination of this Agreement.

(d) Notice to Lender and Tax Equity Investor. Seller shall use commercially reasonable efforts to provide Buyer with a notice identifying a single Lender with respect to all Lenders receiving a security interest in the Facility, a single Lender with respect to all back leverage Lenders, and not more than five (5) Tax Equity Investors (if any) to whom default notices are to be issued. Buyer shall provide a copy of the notice of any default of Seller under this Article 9 to such Lender or Tax Equity Investor, as applicable, and Buyer shall afford such Lender or Tax Equity Investor, as applicable, opportunities to cure Events of Default under this Agreement, in each case, to the extent provided in any consent or estoppel entered into under Section 14.2; provided, however, that, so long as Buyer has used commercially reasonable efforts to comply with the foregoing, Buyer's failure to comply with the foregoing shall not give rise to any Default or Event of Default.

(e) Limitation of Remedies, Liability and Damages. EXCEPT AS EXPRESSLY SET FORTH HEREIN, THERE IS NO WARRANTY OF

MERCHANTABILITY OR FITNESS FOR A PARTICULAR PURPOSE, AND ANY AND ALL IMPLIED WARRANTIES ARE DISCLAIMED. THE PARTIES CONFIRM THAT THE EXPRESS REMEDIES AND MEASURES OF DAMAGES PROVIDED IN THIS AGREEMENT SATISFY THE ESSENTIAL PURPOSES HEREOF. FOR BREACH OF ANY PROVISION FOR WHICH AN EXPRESS REMEDY OR MEASURE OF DAMAGES IS PROVIDED, SUCH EXPRESS REMEDY OR MEASURE OF DAMAGES SHALL BE THE SOLE AND EXCLUSIVE REMEDY, THE OBLIGOR'S LIABILITY SHALL BE LIMITED AS SET FORTH IN SUCH PROVISION AND ALL OTHER REMEDIES OR DAMAGES AT LAW OR IN EQUITY ARE WAIVED. IF NO REMEDY OR MEASURE OF DAMAGES IS EXPRESSLY PROVIDED HEREIN, THE OBLIGOR'S LIABILITY SHALL BE LIMITED TO DIRECT ACTUAL DAMAGES ONLY, SUCH DIRECT ACTUAL DAMAGES SHALL BE THE SOLE AND EXCLUSIVE REMEDY, AND ALL OTHER REMEDIES OR DAMAGES AT LAW OR IN EQUITY ARE WAIVED. UNLESS EXPRESSLY HEREIN PROVIDED, NEITHER PARTY SHALL BE LIABLE FOR CONSEQUENTIAL, INCIDENTAL, PUNITIVE, EXEMPLARY OR INDIRECT DAMAGES, LOST PROFITS OR OTHER BUSINESS INTERRUPTION DAMAGES, BY STATUTE, IN TORT OR CONTRACT, UNDER ANY INDEMNITY PROVISION OR OTHERWISE. TO THE EXTENT ANY DAMAGES REQUIRED TO BE PAID HEREUNDER ARE LIQUIDATED, THE PARTIES ACKNOWLEDGE THAT THE DAMAGES ARE DIFFICULT OR IMPOSSIBLE TO DETERMINE, OR OTHERWISE OBTAINING AN ADEQUATE REMEDY IS INCONVENIENT AND THE DAMAGES CALCULATED HEREUNDER CONSTITUTE A REASONABLE APPROXIMATION OF THE HARM OR LOSS.

10. FORCE MAJEURE

10.1 Force Majeure.

(a) The term "**Force Majeure**" means an unusual, unexpected and significant event: (i) that was not within the control of the Party claiming its occurrence; (ii) that could not have been prevented or avoided by such Party through the exercise of reasonable diligence; and (iii) that directly prohibits or prevents such Party from performing its obligations under this Agreement. Under no circumstances shall Force Majeure include (v) any full or partial curtailment in the electric output of the Facility that is caused by or arises from a mechanical or equipment breakdown or other mishap or events or conditions attributable to normal wear and tear, (w) any occurrence or event that merely increases the costs or causes an economic hardship to a Party, (x) any occurrence or event to the extent caused by or contributed to by the Party claiming the Force Majeure, (y) Seller's ability to sell the Products at a price greater than that set out in this Agreement, or (z) Buyer's ability to procure the Products at a price lower than that set out in this Agreement. In addition, a delay or inability to perform attributable to a Party's lack of preparation, a Party's failure to timely obtain and maintain all necessary Permits (excepting the Regulatory Approval) or qualifications, any delay or failure in satisfying the Critical Milestone obligations specified in Section 3.1(a) (other than Section 3.1(a)(v)(B) or 3.1(a)(vi)), a failure to satisfy contractual conditions or commitments, or lack of or deficiency in funding or other resources shall each not constitute a Force Majeure or be the basis for a claim of Force Majeure. Neither Party may raise a claim of Force Majeure based in whole or in part on curtailment by a Transmission Provider unless (A) such Party has contracted for firm transmission with a Transmission Provider for the Products to be delivered to or received at the Delivery Point and

(B) such curtailment is due to “force majeure” or “uncontrollable force” or a similar term as defined under the Transmission Provider’s tariff; provided, however, that existence of the foregoing factors shall not be sufficient to conclusively or presumptively prove the existence of a Force Majeure absent a showing of other facts and circumstances which in the aggregate with such factors establish that a Force Majeure as defined herein has occurred.

(b) Subject to Section 3.1(d), if either Party is unable, wholly or in part, by reason of Force Majeure to perform obligations under this Agreement, such performance shall be excused and suspended so long as the circumstances that give rise to such inability exist or would exist if the Party claiming the Force Majeure used commercially reasonable efforts to cure such circumstances, but for no longer period. The Party whose performance is affected shall give prompt notice thereof; such notice may be given orally or in writing but, if given orally, it shall be promptly confirmed in writing, providing details regarding the nature, extent and expected duration of the Force Majeure, its anticipated effect on the ability of such Party to perform obligations under this Agreement, and the estimated duration of any interruption in service or other adverse effects resulting from such Force Majeure, and shall be updated or supplemented to keep the other Party advised of the effect and remedial measures being undertaken to overcome the Force Majeure. Such inability shall be promptly corrected to the extent it may be corrected through the exercise of due diligence. Neither party shall be liable for any losses or damages arising out of a suspension of performance that occurs because of Force Majeure.

(c) Notwithstanding the foregoing and subject to Sections 3.1(d) and 10.1(b), if the Force Majeure prevents full or partial performance under this Agreement for a period of [REDACTED] or more, the Party whose performance is not prevented by Force Majeure shall have the right to terminate this Agreement upon written notice to the other Party and without further recourse; provided, however, that such [REDACTED] period shall be extended to [REDACTED] if such Force Majeure results directly in a Catastrophic Failure that cannot be remedied in such [REDACTED] period using commercially reasonable efforts and Seller provides Buyer with documentation demonstrating that Seller has taken action (including without limitation arranging for the repair and/or ordering replacements for the affected Key Equipment and arranging for the vessels and personnel required to repair that Key Equipment and/or to install that replacement Key Equipment) promptly after the occurrence of such Force Majeure to return the Facility to full performance under this Agreement; and provided further that Buyer shall have no right to terminate this Agreement pursuant to this Section 10.1(c) if the Force Majeure prevents only partial (but not full) performance of the obligations of Seller to sell and Deliver the Products and does not otherwise cause the Biennial Average Real-Time High Operating Limit to be less than fifty percent (50%) of the Actual Facility Size. In no event will any delay or failure of performance caused by any conditions or events of Force Majeure extend this Agreement beyond its stated Term.

11. DISPUTE RESOLUTION

11.1 Dispute Resolution. In the event of any dispute, controversy or claim between the Parties arising out of or relating to this Agreement (collectively, a “**Dispute**”), in addition to any other remedies provided hereunder, the Parties shall initially attempt to resolve such Dispute through consultations between the Parties. If the Dispute has not been resolved within fifteen

(15) Business Days after written notice of such Dispute has been given, then either Party may seek to resolve such Dispute in the state and federal courts located in the Commonwealth of Massachusetts and any appellate court from any thereof; provided, however, if the Dispute is subject to FERC's jurisdiction over wholesale power contracts, then either Party may elect to proceed with the mediation through FERC's Dispute Resolution Service; provided, however, that if one Party fails to participate in the consultations as provided in this Section 11.1, the other Party can initiate mediation prior to the expiration of the fifteen (15) Business Days. Unless otherwise agreed, the Parties will select a mediator from the FERC panel. The Parties may, by written agreement signed by both Parties, alter any time deadline, location(s) for meeting(s), or procedure outlined herein or in FERC's rules for mediation. The procedure specified herein shall be the sole and exclusive procedure for the resolution of Disputes. To the fullest extent permitted by law, any mediation proceeding and any settlement shall be maintained in confidence by the Parties.

11.2 Allocation of Dispute Costs. The fees and expenses associated with mediation shall be divided equally between the Parties, and each Party shall be responsible for its own legal fees, including but not limited to attorney fees, associated with any Dispute.

11.3 Consent to Jurisdiction. Subject to Section 11.1, the Parties agree to the exclusive jurisdiction of the state and federal courts located in the Commonwealth of Massachusetts and any appellate court from any appeal thereof for any legal proceedings that may be brought by a Party arising out of or in connection with any Dispute.

11.4 Waiver of Jury Trial and Inconvenient Forum Claim. EACH PARTY HEREBY WAIVES TO THE FULLEST EXTENT PERMITTED BY LAW ANY RIGHT IT MAY HAVE TO A TRIAL BY JURY IN RESPECT OF ANY SUIT, ACTION OR PROCEEDING ARISING OUT OF, RESULTING FROM OR IN ANY WAY RELATING TO THIS AGREEMENT. BOTH PARTIES IRREVOCABLY WAIVE, TO THE FULLEST EXTENT PERMITTED BY LAW, ANY OBJECTION THAT THEY MAY NOW OR HEREAFTER HAVE TO THE LAYING OF VENUE AS SET FORTH IN THIS ARTICLE 11 AND ANY CLAIM THAT ANY SUCH PROCEEDING HAS BEEN BROUGHT IN ANY INCONVENIENT FORUM.

12. CONFIDENTIALITY

12.1 Nondisclosure. Buyer and Seller each agrees not to disclose to any Person and to keep confidential, and to cause and instruct its Affiliates, officers, directors, employees, agents, partners and representatives not to disclose to any Person and to keep confidential, any non-public information relating to the terms and provisions of this Agreement, and any information relating to the Products to be supplied by Seller hereunder, and such other non-public information that is designated as "Confidential." Notwithstanding the foregoing, any such information may be disclosed:

(a) to the extent Buyer determines it is appropriate in connection with efforts to obtain or maintain the Regulatory Approval or to seek rate recovery for amounts expended by Buyer under this Agreement;

(b) as required by applicable laws, regulations, filing requirements, rules or orders or by any subpoena or similar legal process of any Governmental Entity so long as the disclosing Party gives the non-disclosing Party written notice at least three (3) Business Days prior to such disclosure, if practicable and legally permissible;

(c) to the Affiliates of either Party and their respective officers, directors, employees, agents, partners and representatives or the consultants, auditors, advisors (including financial advisors, attorneys and accountants), investors and potential investors (and their advisors (including financial advisors, attorneys and accountants)), and lenders and potential lenders (and their advisors (including financial advisors, attorneys and accountants)) of either Party or their Affiliates, but solely to the extent they have a need to know that information;

(d) in order to comply with any rule or regulation of ISO-NE, other system operators, any stock exchange or similar Person or for financial disclosure purposes;

(e) to the extent the non-disclosing Party shall have consented in writing prior to any such disclosure; and

(f) to the extent that the information was previously made publicly available other than as a result of a breach of this Section 12.1 or to the extent that the information was independently developed by the receiving party without use of the confidential information;

provided, however, in each case, that the Party seeking such disclosure shall, to the extent practicable, use commercially reasonable efforts to prevent or limit the disclosure. The Parties shall be entitled to all remedies available at law or in equity to enforce or seek relief in connection with this Section 12.1. Each Party shall be responsible for any disclosure of confidential information in breach of this Agreement by its Affiliates or their respective officers, directors, employees, agents, partners or representatives or the consultants, auditors, advisors (including financial advisors, attorneys or accountants), investors or potential investors (or their advisors (including financial advisors, attorneys or accountants)), or lenders or potential lenders (or their advisors (including financial advisors, attorneys or accountants)) of such Party or its Affiliates.

12.2 Public Statements. No public statement, press release or other voluntary publication regarding this Agreement or the transactions to be made hereunder shall be made or issued without the prior consent of the other Party.

13. INDEMNIFICATION

13.1 Indemnification Obligations. Seller shall indemnify, defend and hold Buyer and its partners, shareholders, directors, officers, employees and agents (including, but not limited to, Affiliates and contractors and their employees), harmless from and against all liabilities, damages, losses, penalties, claims, demands, suits and proceedings of any nature whatsoever arising from or related to Seller's negligence, gross negligence, or willful misconduct, or Seller's failure to satisfy any obligation or liability under this Agreement; provided that Seller shall not be responsible for any losses to the extent that those losses are caused by the negligence, gross negligence, or willful misconduct of the indemnified party. In the event Seller is obligated to

indemnify and hold any indemnified party harmless under this Agreement, the amount owing to such indemnified party shall be limited to the amount of such indemnified party's actual loss net of any insurance proceeds received by such indemnified party following a reasonable effort by such indemnified party to obtain such insurance proceeds.

13.2 Notice of Indemnified Claim; Failure to Defend. Promptly after receipt by an indemnified party of any claim or notice of the commencement of any claim, demand, suit or proceeding of any nature as to which Seller may be obligated to indemnify and hold such indemnified party harmless under this Agreement, such indemnified party shall notify Seller in writing of such fact. If Seller fails to assume the defense of a claim meriting indemnification, Buyer may at the expense of Seller contest, settle or pay such claim, and Seller shall promptly reimburse Buyer for all costs incurred by Buyer associated therewith.

14. ASSIGNMENT AND CHANGE OF CONTROL

14.1 Prohibition on Assignments. Except as permitted under this Article 14, this Agreement (and any portion thereof) may not be assigned by either Party without the prior written consent of the other Party, which consent may not be unreasonably withheld, conditioned or delayed. The Party requesting the other Party's consent to an assignment of this Agreement will reimburse such other Party for the documented, reasonable "out of pocket" costs and expenses such other Party incurs in connection with that consent, without regard to whether such consent is provided. When assignable, this Agreement shall be binding upon, shall inure to the benefit of, and may be performed by, the successors and assignees of the Parties, except that no assignment, pledge or other transfer of this Agreement by either Party shall operate to release the assignor, pledgor, or transferor from any of its obligations under this Agreement (and shall not impair any Credit Support given by Seller hereunder) unless the other Party (or its successors or assigns) consents in writing to the assignment, pledge or other transfer and expressly releases the assignor, pledgor, or transferor from its obligations thereunder.

14.2 Permitted Assignment by Seller. Buyer's consent shall not be required for Seller to pledge or assign the Facility, this Agreement or the revenues under this Agreement to any Lender as security for any Financing of the Facility or to assign the Facility or this Agreement to an Affiliate if all required Credit Support remains in place. If Seller requests Buyer's consent to an assignment, Buyer shall provide that consent subject to Buyer's execution of a consent to assignment in a commercially reasonable form acceptable to Buyer and Seller. Upon Seller's reasonable request in connection with any Financing (including any such back leverage financing or Tax Equity Transaction) with respect to Seller or any Affiliate of Seller, Buyer shall execute a consent or estoppel in a commercially reasonable form acceptable to Buyer and Seller and Buyer shall provide such information or other documents to Seller or any Lender (including any such back leverage Lender or Tax Equity Investor) as is customarily provided in connection with Financings of a similar nature. Seller will use commercially reasonable efforts to conform all consents and estoppels requested under this Section 14.2 to a single form, to the extent practicable. Seller will reimburse Buyer for the documented, reasonable "out of pocket" costs and expenses Buyer incurs in connection with that consent or estoppel, without regarding to whether such consent or estoppel is provided.

14.3 Change in Control over Seller. Buyer's consent shall be required for any change in Control over Seller, which consent shall not be unreasonably withheld, conditioned or delayed and shall be provided if Buyer reasonably determines that such change in Control does not have a material adverse effect on Seller's creditworthiness or Seller's ability to perform its obligations under this Agreement; provided however, the Parties agree that Buyer's consent shall not be required in connection with the following: (i) any assignment of all or a portion of the equity interests in Seller or in any Affiliate of Seller to any Lender as security for any Financing, and any foreclosure on or other exercise by any Lender of any rights and remedy with respect to such equity interests in connection with such Financing; (ii) any change in the relative ownership percentages of equity interest in Seller amongst any Parent Entities as of the Effective Date; (iii) any direct or indirect assignment of all or a portion of the equity interests in Seller to Engie, S.A. (or any of its Affiliates) or (iv) any merger or consolidation of any Indirect Parent Entity with or into another Person or any exchange of all or any portion of the common stock or other equity interests of any Indirect Parent Entity for cash, securities or other property or any acquisition, reorganization, transfer of economic interest or any other transaction or series of transactions having similar effects involving all or any portion of the common stock or other equity interests in, or assets of, any Indirect Parent Entity.

14.4 Permitted Assignment by Buyer. Buyer shall have the right to assign this Agreement without consent of Seller (a) in connection with any merger or consolidation of Buyer with or into another Person or any exchange of all of the common stock or other equity interests of Buyer or Buyer's parent for cash, securities or other property or any acquisition, reorganization, or other similar corporate transaction involving all or substantially all of the common stock or other equity interests in, or assets of, Buyer, or (b) to any substitute purchaser of the Products so long as in the case of either clause (a) or clause (b) of this Section 14.4, (i) either (x) the proposed assignee's credit rating is at least either BBB- from S&P or Baa3 from Moody's or (y) the proposed assignee's credit rating is equal to or better than that of Buyer at the time of the proposed assignment and the proposed assignee is regulated by the MDPU or another Governmental Entity that authorizes the recovery of Buyer's costs incurred under this Agreement in retail rates charged by the proposed assignee to the same extent as such recovery is authorized in the Regulatory Approval, and (ii) such assignment or, in the case of clause (a) above, the transaction associated with such assignment has been approved by the MDPU or the appropriate Governmental Entity.

14.5 Prohibited Assignments. Any purported assignment of this Agreement not in compliance with the provisions of this Article 14 shall be null and void.

15. TITLE; RISK OF LOSS

Seller shall have title to and risk of loss related to the Delivery of the Energy to and at the Delivery Point. Title to and risk of loss related to Buyer's Percentage Entitlement of the Energy shall transfer from Seller to Buyer from and after the Delivery Point. Title and risk of loss related to Buyer's Percentage Entitlement of the RECs shall transfer to Buyer when the same are credited to Buyer's GIS account(s) or the GIS account(s) designated by Buyer to Seller in writing. Seller warrants that it shall deliver to Buyer the Products free and clear of all liens and claims therein or thereto by any Person.

16. AUDIT

16.1 Audit. Each Party shall have the right, upon reasonable advance notice, and at its sole expense (unless the other Party has defaulted under this Agreement, in which case the Defaulting Party shall bear the expense) and during normal working hours, to examine the records of the other Party to the extent reasonably necessary to verify the accuracy of any statement, charge or computation made pursuant to this Agreement. If requested, a Party shall provide to the other Party additional information documenting the quantities of Products delivered or provided hereunder. If any such examination reveals any overcharge or undercharge, the necessary adjustments in such statement and the payments thereof shall be made promptly and shall include interest at the Late Payment Rate from the date the overpayment or underpayment was made until credited or paid.

16.2 Access to Financial Information. Seller shall provide to Buyer within fifteen (15) days of receipt of Buyer’s written request applicable financial information and statements of Seller and its Affiliates as well as access to financial personnel, as reasonably necessary for Buyer to address any inquiries from a Governmental Entity relating to Seller’s financial resources.

17. NOTICES

Any notice or communication given pursuant hereto shall be in writing and (1) delivered personally (personally delivered notices shall be deemed given upon written acknowledgment of receipt after delivery to the address specified or upon refusal of receipt); or (2) mailed by registered or certified mail, postage prepaid (mailed notices shall be deemed given on the actual date of delivery, as set forth in the return receipt, or upon refusal of receipt); or (3) delivered by fax or electronic mail (notices sent by fax or electronic mail shall be deemed given upon confirmation of delivery); or (4) by reputable overnight courier; in each case addressed as follows or to such other addresses as may hereafter be designated by either Party to the other in writing:

If to Buyer: Attn: Renewable Contract Manager, Environmental Transactions
National Grid
100 East Old Country Road, Second Floor
Hicksville, NY 11801-4218
Email: RenewableContracts@nationalgrid.com
With a copy to: ElectricSupply@nationalgrid.com

With a copy to: Legal Department
Attn: Tonya Murphy, Esq.
Senior Counsel
National Grid
40 Sylvan Road
Waltham, MA 02451-1120
Email: tonya.murphy@nationalgrid.com

If to Seller: Mayflower Wind Energy LLC
 281 Albany Street
 Cambridge, MA 02139
 Attention: John Hartnett
 Telephone: 315-569-0370
 Email: j.hartnett@shell.com

With copies to: EDPR Offshore North America LLC
 808 Travis, Suite 700
 Houston, Texas 77002
 Attention: Ann McDowell - Assistant Secretary
 Telephone: 713-265-0350
 Email: ann.mcdowell@edpr.com

 Shell New Energies US LLC
 150 N. Dairy Ashford
 Houston, Texas 77079
 Attention: Legal - Wind
 Telephone: 832-337-2724
 Email: brian.murdock@shell.com

18. WAIVER AND MODIFICATION

This Agreement may be amended and its provisions and the effects thereof waived only by a writing executed by the Parties, and no subsequent conduct of any Party or course of dealings between the Parties shall effect or be deemed to effect any such amendment or waiver. No waiver of any of the provisions of this Agreement shall be deemed or shall constitute a waiver of any other provision hereof (whether or not similar), nor shall such waiver constitute a continuing waiver unless otherwise expressly provided. The failure of either Party to enforce any provision of this Agreement shall not be construed as a waiver of or acquiescence in or to such provision. Buyer shall determine in its sole discretion whether any amendment or waiver of the provisions of this Agreement shall require Regulatory Approval or MDPU filing and/or approval. If Buyer determines that any such approval or filing is required, then such amendment or waiver shall not become effective unless and until Regulatory Approval or such other approval is received, or such MDPU filing is made and any requested MDPU approval is received.

19. INTERPRETATION

19.1 Choice of Law. Interpretation and performance of this Agreement shall be in accordance with, and shall be controlled by, the laws of the Commonwealth of Massachusetts (without regard to its principles of conflicts of law).

19.2 Headings. Article and Section headings are for convenience only and shall not affect the interpretation of this Agreement. References to articles, sections and exhibits are, unless the context otherwise requires, references to articles, sections and exhibits of this

Agreement. The words “hereof” and “hereunder” shall refer to this Agreement as a whole and not to any particular provision of this Agreement.

19.3 Forward Contract. The Parties acknowledge and agree that this Agreement and the transactions contemplated hereunder are a “forward contract” within the meaning of the United States Bankruptcy Code.

19.4 Standard of Review. The Parties acknowledge and agree that the standard of review for any avoidance, breach, rejection, termination or other cessation of performance of or changes to any portion of this integrated, non-severable Agreement (as described in Section 22) over which FERC has jurisdiction, whether proposed by Seller, by Buyer, by a non-party of, by FERC acting *sua sponte* shall be the “public interest” standard of review set forth in United Gas Pipe Line Co. v. Mobile Gas Serv. Co., 350 U.S. 332 (1956) and Federal Power Comm’n v. Sierra Pac. Power Co., 350 U.S. 348 (1956). Each Party agrees that if it seeks to amend any applicable power sales tariff during the Term, such amendment shall not in any way materially and adversely affect this Agreement without the prior written consent of the other Party. Each Party further agrees that it shall not assert, or defend itself, on the basis that any applicable tariff is inconsistent with this Agreement.

19.5 Change in ISO-NE Rules and ISO-NE Practices. This Agreement is subject to the ISO-NE Rules and ISO-NE Practices. If, during the Term of this Agreement, any ISO-NE Rule or ISO-NE Practice is terminated, modified or amended or is otherwise no longer applicable, resulting in a material alteration of a material right or obligation of a Party hereunder, the Parties agree to negotiate in good faith in an attempt to amend or clarify this Agreement to embody the Parties’ original intent regarding their respective rights and obligations under this Agreement, provided that neither Party shall have any obligation to agree to any particular amendment or clarification of this Agreement. The intent of the Parties is that any such amendment or clarification reflect, as closely as possible, the intent, substance and effect of the ISO-NE Rule or ISO-NE Practice being replaced, modified, amended or made inapplicable as such ISO-NE Rule or ISO-NE Practice was in effect prior to such termination, modification, amendment, or inapplicability, provided that such amendment or clarification shall not in any event alter (i) the purchase and sale obligations of the Parties pursuant to this Agreement, or (ii) the Price or the Adjusted Price, as applicable.

19.6 Dodd Frank Act Representations. The Parties agree that this Agreement (including all transactions reflected herein) is not a “swap” within the meaning of the Commodity Exchange Act and the rules, interpretations and other guidance of the Commodity Futures Trading Commission (“**CFTC Rules**”), and that the primary intent of this Agreement is physical settlement (i.e., actual transfer of ownership) of the nonfinancial commodity and not solely to transfer price risk. In reliance upon such agreement, each Party represents to the other that:

(a) With respect to the commodity to be purchased and sold hereunder, it is a commercial market participant, a commercial entity and a commercial party, as such terms are used in the CFTC Rules, and it is a producer, processor, or commercial user of, or a merchant handling, the commodity and it is entering into this Agreement for purposes related to its business as such;

(b) It is not registered or required to be registered under the CFTC Rules as a swap dealer or a major swap participant;

(c) It has entered into this Agreement in connection with the conduct of its regular business and it has the capacity or ability to regularly make or take delivery of the commodity to be purchased and sold hereunder;

(d) With respect to the commodity to be purchased and sold hereunder, it intends to make or take physical delivery of the commodity;

(e) At the time that the Parties enter into this Agreement, any embedded volumetric optionality in this Agreement is primarily intended by the holder of such option or optionality to address physical factors or regulatory requirements that reasonably influence demand for, or supply of, the commodity to be purchased and sold hereunder;

(f) With respect to any embedded commodity option in this Agreement, such option is intended to be physically settled so that, if exercised, the option would result in the sale of the commodity to be purchased or sold hereunder for immediate or deferred shipment or delivery; and

(g) The commodity to be purchased and sold hereunder is a nonfinancial commodity, and is also an exempt commodity or an agricultural commodity, as such terms are defined and interpreted in the CFTC Rules.

To the extent that reporting of any transactions related to this Agreement is required by the CFTC Rules, the Parties agree that Seller shall be responsible for such reporting (the “**Reporting Party**”). The Reporting Party’s reporting obligations shall continue until the reporting obligation has expired or has been terminated in accordance with CFTC Rules. Buyer, as the Party that is not undertaking the reporting obligations shall timely provide the Reporting Party all necessary information requested by the Reporting Party for it to comply with CFTC Rules.

19.7 Change in Law or Buyer’s Accounting Treatment, Subsequent Judicial or Regulatory Action.

(a) If, during the Term of this Agreement, there is a change in Law or accounting standards or rules or a change in the interpretation or applicability thereof that would result in adverse balance sheet or creditworthiness impacts on Buyer associated with this Agreement or the amounts paid for Products purchased hereunder, Buyer shall prepare an amendment to this Agreement (x) to avoid or mitigate such impacts, while preserving the existing terms of this Agreement not impacted by such changes, and (y) in a manner that, to the extent possible, mitigates any material adverse effect(s) on Seller (as identified by Seller, acting reasonably) that could reasonably be expected to result from such amendment, provided that such amendment does not (unless Seller otherwise agrees) alter: (i) the purchase and sale obligations of the Parties pursuant to this Agreement or (ii) the Price or the Adjusted Price, as applicable. Buyer and Seller shall negotiate in good faith in an effort to agree on such amendment.



(b) Upon a determination by a court or regulatory body having jurisdiction over this Agreement or any of the Parties hereto, or over the establishment and enforcement of any of the statutes or regulations or orders or actions of regulatory agencies (including the MDPU) supporting this Agreement or the rights or obligations of the Parties hereunder that any of the statutes or regulations supporting this Agreement or the rights or obligations of the Parties hereunder, or orders of or actions of regulatory agencies (including the MDPU) implementing such statutes or regulations, or this Agreement on its face or as applied, violates any Law (including the State or Federal Constitution) (an “**Adverse Determination**”), each Party shall have the right to suspend performance under this Agreement without liability. Seller may deliver and sell Products to a third party during any period of time for which Buyer suspends payments or purchases or Seller suspends Deliveries under this Section. Upon an Adverse Determination becoming final and non-appealable, this Agreement shall be rendered null and void.

20. CALCULATIONS

All calculations of damages, losses and Termination Payments due under this Agreement shall be determined by the Party entitled to receive such losses, damages or Termination Payment in good faith and in a commercially reasonable manner, and such Party shall provide the other Party with a detailed calculation thereof and any supporting documentation at the time such calculation is made.

21. COUNTERPARTS; FACSIMILE OR PDF SIGNATURES

Any number of counterparts of this Agreement may be executed, and each shall have the same force and effect as an original. Facsimile or PDF signatures hereon or on any notice or other instrument delivered under this Agreement shall have the same force and effect as original signatures.

22. NO DUTY TO THIRD PARTIES

Except as provided in any consent to assignment of this Agreement, nothing in this Agreement nor any action taken hereunder shall be construed to create any duty, liability or standard of care to any Person not a Party to this Agreement.

23. SEVERABILITY

Except as otherwise provided in Article 8, Section 19.5 or Section 19.7, if any term or provision of this Agreement or the interpretation or application of any term or provision to any prior circumstance is held to be unenforceable, illegal or invalid by a court or agency of competent jurisdiction, the remainder of this Agreement and the interpretation or application of all other terms or provisions to Persons or circumstances other than those which are unenforceable, illegal or invalid shall not be affected thereby, and each term and provision shall be valid and be enforced to the fullest extent permitted by law so long as all essential terms and conditions of this Agreement for both Parties remain valid, binding and enforceable and have not been declared to be unenforceable, illegal or invalid by a Governmental Entity of competent jurisdiction. The Parties acknowledge and agree that essential terms and conditions of this

Agreement for each Party include, without limitation, all pricing and payment terms and conditions of this Agreement, and that the essential terms and conditions of this Agreement for Buyer also include, without limitation, the terms and conditions of Section 19.7 of this Agreement.

24. INDEPENDENT CONTRACTOR

Nothing in this Agreement shall be construed as creating any relationship between Buyer and Seller other than that of Seller as independent contractor for the sale of Products, and Buyer as principal and purchaser of the same. Neither Party shall be deemed to be the agent of the other Party for any purpose by reason of this Agreement, and no partnership or joint venture or fiduciary relationship between the Parties is intended to be created hereby. Nothing in this Agreement shall be construed as creating any relationship between Buyer and the Interconnecting Utility.



25. ENTIRE AGREEMENT

This Agreement shall constitute the entire agreement and understanding between the Parties hereto and shall supersede all prior agreements and communications.

[Signature page follows]

IN WITNESS WHEREOF, each of Buyer and Seller has caused this Agreement to be duly executed on its behalf as of the date first above written.

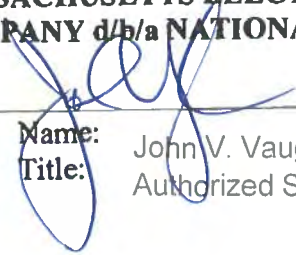
MASSACHUSETTS ELECTRIC COMPANY AND NANTUCKET ELECTRIC COMPANY d/b/a NATIONAL GRID, as Buyer

By: _____  

Name: John V. Vaughn
Title: Authorized Signatory

MAYFLOWER WIND ENERGY LLC, as Seller

By: _____
Name:
Title:

IN WITNESS WHEREOF, each of Buyer and Seller has caused this Agreement to be duly executed on its behalf as of the date first above written.

MASSACHUSETTS ELECTRIC COMPANY AND NANTUCKET ELECTRIC COMPANY d/b/a NATIONAL GRID, as Buyer

By: _____

Name:
Title:

MAYFLOWER WIND ENERGY LLC, as Seller

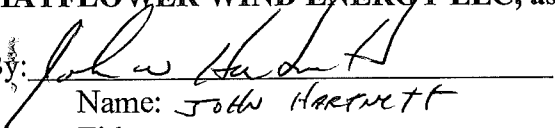
By:  _____

Name: John Harrett
Title: President

EXHIBIT A

DESCRIPTION OF FACILITY

Project:

An offshore wind electric generation facility to be located on a portion of the Outer Continental Shelf in Bureau of Ocean Energy Management Lease OCS-A 0521 area. The Project will include the Facility, the Other Facility and certain other generating and related facilities to be developed by Seller and/or its Affiliates (collectively, the “**Additional Facilities**”).

Facility:

The Facility refers to a portion of the Project that consists of certain turbines with aggregate expected nameplate capacity of approximately 408 MW (rounded up to a whole number multiple of the nameplate capacity of one turbine used in the Facility, subject to Section 3.3(c)), as preliminarily indicated below. The number and location of turbines included in the Facility will be based on the final turbine model selected prior to the Financial Closing Date. The table below will be updated to specify the serial number of each turbine included in the Facility as built and configured as of the Commercial Operation Date.

Preliminary Site Plan

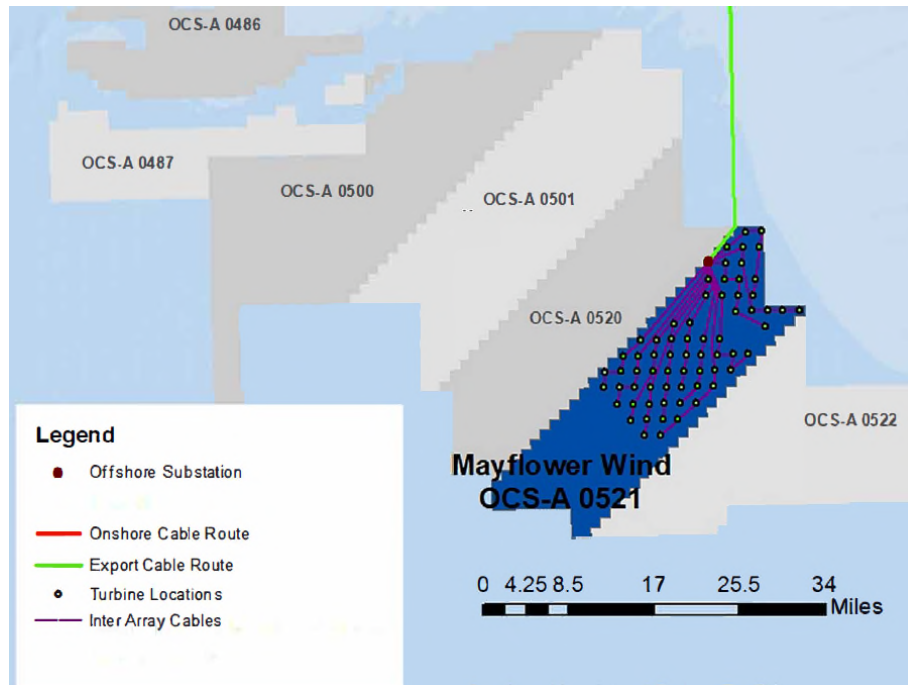

Preliminary Schematic Design

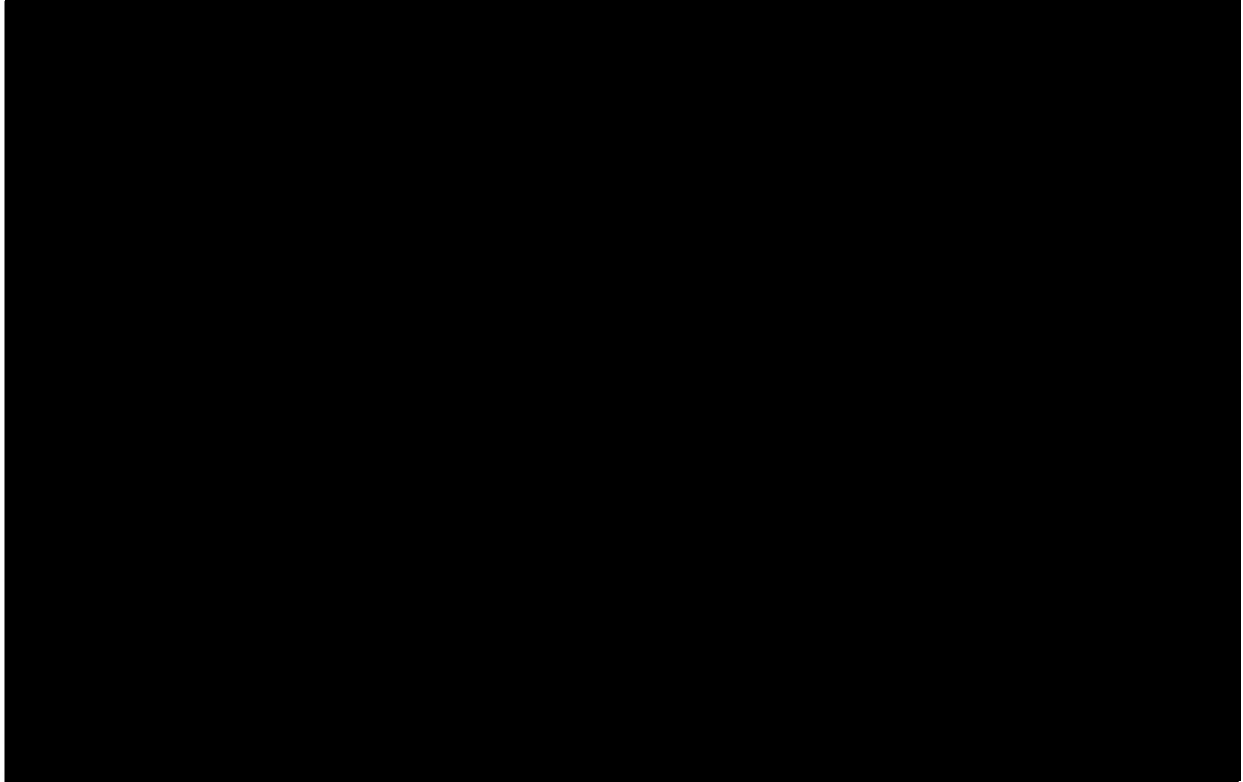

Preliminary Land Fall and Cable Route

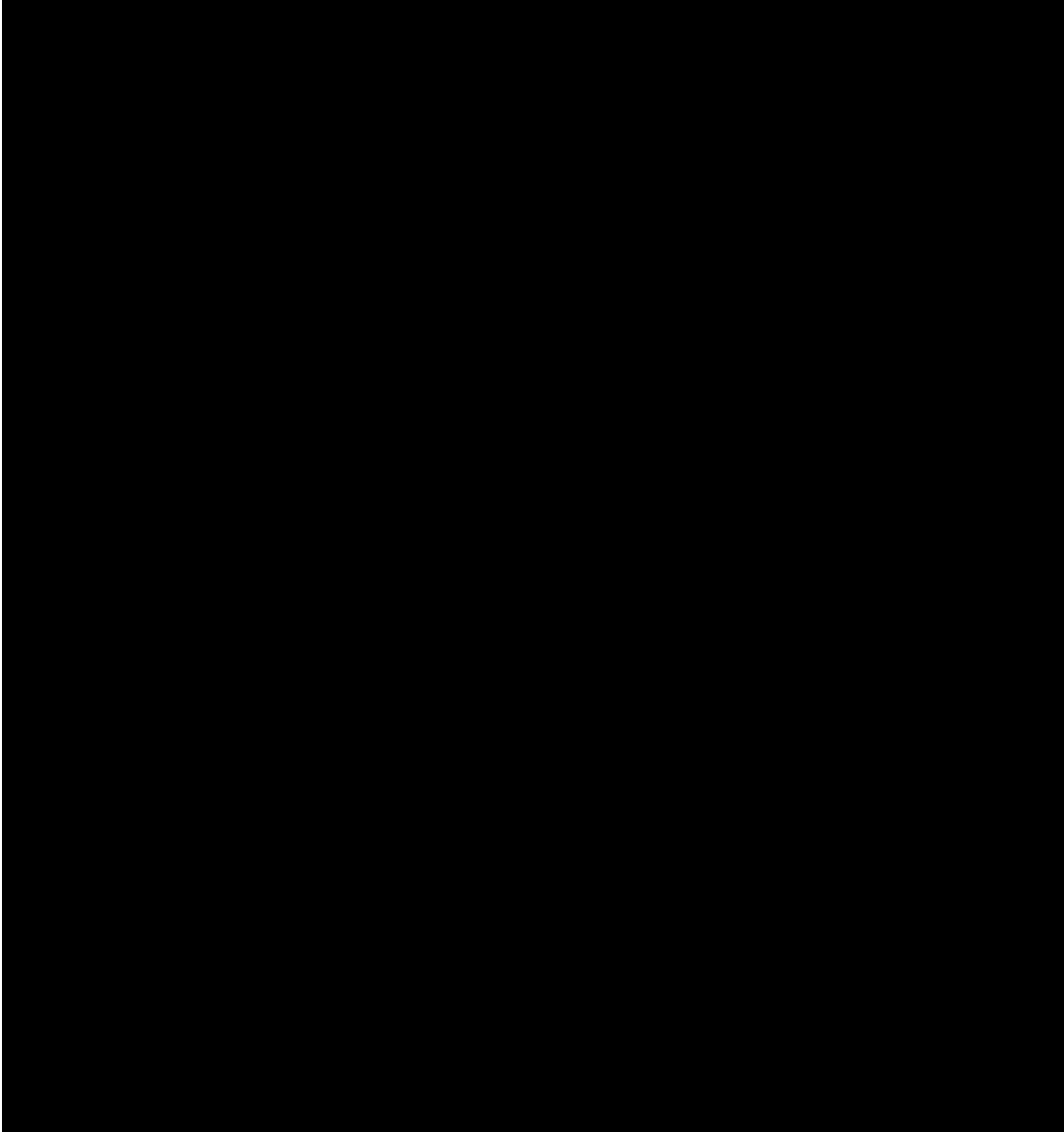

Facility Turbines

Turbine	Serial Number	Turbine	Serial Number
1	To be identified	21	To be identified (if necessary)
2	To be identified (if necessary)	22	To be identified (if necessary)
3	To be identified (if necessary)	23	To be identified (if necessary)
4	To be identified (if necessary)	24	To be identified (if necessary)
5	To be identified (if necessary)	25	To be identified (if necessary)
6	To be identified (if necessary)	26	To be identified (if necessary)
7	To be identified (if necessary)	27	To be identified (if necessary)
8	To be identified (if necessary)	28	To be identified (if necessary)
9	To be identified (if necessary)	29	To be identified (if necessary)
10	To be identified (if necessary)	30	To be identified (if necessary)
11	To be identified (if necessary)	31	To be identified (if necessary)
12	To be identified (if necessary)	32	To be identified (if necessary)
13	To be identified (if necessary)	33	To be identified (if necessary)
14	To be identified (if necessary)	34	To be identified (if necessary)
15	To be identified (if necessary)	35	To be identified (if necessary)
16	To be identified (if necessary)	36	To be identified (if necessary)
17	To be identified (if necessary)	37	To be identified (if necessary)
18	To be identified (if necessary)	38	To be identified (if necessary)
19	To be identified (if necessary)	39	To be identified (if necessary)
20	To be identified (if necessary)	40	To be identified (if necessary)

Shared Equipment:

The Facility will consist of, or have the right to use, the components of the Project (other than the turbines) required to deliver Products to the Delivery Point (the “**Shared Equipment**”). The Shared Equipment will be shared with the Other Facility and the Additional Facilities and will include the following:

- Offshore substation platform
- Export cables
- Inter-array cables
- Onshore substation
- Onshore routing
- Switching station and the point of interconnection

In the event the Shared Equipment is built at a nameplate capacity less than the aggregate nameplate capacity of the Facility, the Other Facility, and the Additional Facilities, the Facility and the Other Facility shall (a) have priority over the Additional Facilities to the extent required to avoid and/or minimize curtailment of the Facility or the Other Facility and (b) be allocated use

of the operational capability of such Shared Equipment at any time up to the level necessary to accommodate the delivery of the full real-time production capability of the Facility and the Other Facility at such time, before use is allocated to the Additional Facilities. If curtailment of the Facility and the Other Facility is still necessary in such an event, any such curtailment shall be allocated between the Facility and the Other Facility based on their Real-Time High Operating Limits (as defined in the ISO-NE Rules) at such time.

In the event the Shared Equipment is built at a nameplate capacity less than the aggregate nameplate capacity of the Facility, the Other Facility, and the Additional Facilities, but such Shared Equipment was initially built and has been subsequently maintained at a nameplate capacity to fully accommodate delivery of the aggregate nameplate capacity of the Facility, the Other Facility, and a specific and distinguishable generating facility among the Additional Facilities (i.e., the “**Third Facility**”) with a nameplate capacity no greater than the nameplate capacity of the Shared Equipment at the time the Third Facility is placed in service minus the aggregate nameplate capacity of the Facility and the Other Facility hereunder and under the Phase II Mayflower Wind Power Purchase Agreement, then the Facility, the Other Facility, and the Third Facility shall (a) have priority over all other Additional Facilities to the extent required to avoid and/or minimize curtailment of the Facility, the Other Facility, and the Third Facility and (b) be allocated use of the operational capability of such Shared Equipment at any time up to the level necessary to accommodate the delivery of the full real-time production capability of the Facility, the Other Facility, and the Third Facility at such time, before use is allocated to any other Additional Facilities. If curtailment of the Facility, the Other Facility, and the Third Facility is still necessary in such an event, any such curtailment shall be allocated between the Facility, the Other Facility, and the Third Facility based on their Real-Time High Operating Limits (as defined in the ISO-NE Rules) at such time.

In the event the Shared Equipment is built at a nameplate capacity equal to or greater than the aggregate nameplate capacity of the Facility, the Other Facility, and all Additional Facilities, but the Shared Equipment is not fully operational at any time, then the Facility and the Other Facility shall not be curtailed to a level less than an amount equal to (i) the energy capable of being delivered by the Shared Equipment at such time, multiplied by (ii) the ratio of (A) the aggregate nameplate capacity of the Facility and the Other Facility, divided by (B) the aggregate nameplate capacity of the Facility, the Other Facility, and the Additional Facilities. Moreover, such level shall be raised (i.e., the curtailment of the Facility and the Other Facility decreased) to the extent the real-time production capabilities of the Additional Facilities at such time would result in underutilized operational capability of such Shared Equipment at such time, and any curtailment of the Additional Facilities shall similarly be decreased to the extent the real-time production capabilities of the Facility and the Other Facility at such time would result in underutilized operational capability of such Shared Equipment at such time. In any such event, curtailment shall be allocated between the Facility and the Other Facility based on their Real-Time High Operating Limits (as defined in the ISO-NE Rules) at such time.

In no event will the Shared Equipment have an as-built nameplate capacity that is less than the aggregate nameplate capacity of the Facility and the Other Facility at any time during the Services Term. The Seller shall provide information and documentation to the Buyer on an

ongoing basis regarding the capacity and allocation of the Shared Equipment.¹

Delivery Point:

The proposed new Bourne 345 kV switching station that connects to NSTAR Electric Company 345 kV lines 322 and 342 near Bourne, Massachusetts. The Delivery Point will be a Node on the Pool Transmission Facilities to be confirmed by ISO-NE.

Proposed Facility Size:

408 MW

¹ In the event that Seller reports to ISO-NE a Real-Time High Operating Limit representing an aggregate Real-Time High Operating Limit for the combination of the Facility, the Other Facility, and the Additional Facilities, the Real-Time Operating Limit as used in this Exhibit A shall represent the equivalent limit(s) determined for the Facility as well as the Other Facility and the Third Facility based on the turbine- specific limitations used by Seller to calculate that aggregate Real-Time High Operating Limit.

EXHIBIT B

SELLER’S CRITICAL MILESTONES – PERMITS

Governmental Agency	Permits
Federal	
Bureau of Ocean Energy Management (BOEM)	Site Assessment Plan (SAP) Approval
	Construction and Operations Plan (COP) Approval
	Endangered Species Act (ESA) Section 7 Consultation with U.S. Fish and Wildlife Service (USFWS)
Federal Aviation Administration (FAA/BOEM)	Determinations of No Hazard (DNH)
U.S. Army Corps of Engineers (USACE)	Individual Clean Water Act (CWA) Section 404
	Rivers and Harbors Act of 1899 Section 10 Permit
U.S. Coast Guard (USCG)	Private Aids to Navigation Authorization
U.S. Environmental Protection Agency (EPA)	National Pollutant Discharge Elimination System (NPDES) General Permit for Construction Activities
	Outer Continental Shelf (OCS) Permit
National Oceanic and Atmospheric Administration (NOAA) National Marine Fisheries Service	Marine Mammal Protection Act (MMPA) Incidental Harassment Authorization (IHA) or Letter of Authorization (LOA)
	Endangered Species Act Section 7 Consultation
State	
Massachusetts Environmental Policy Act (MEPA) Office	Massachusetts Environmental Protection Act (MEPA) Environmental Notification Form (ENF) or Environmental Impact Report (EIR); Certificate of Secretary of Energy and Environmental Affairs
Massachusetts Energy Facility Siting Board (EFSB)	M.G.L. c. 164, § 69 Approval to Construct
Massachusetts Department of Public Utilities (MA DPU)	G.L. c. 164, § 72, Approval to Construct
	G.L. c. 40A, § 3 Zoning Exemption (if needed)
Massachusetts Department of Environmental Protection (MassDEP)	Chapter 91 Waterways License/Permit for dredge, fill, or structures in waterways or tidelands
	Section 401 Water Quality Certification
Massachusetts Department of Transportation (MassDOT)	State Highway Access/Easement/Right-of-Way Permit(s)
	Rail Division Use and Occupancy License (if needed)
Massachusetts Natural Heritage and Endangered Species Program (NHESP)	Conservation and Management Permit (if needed)
Regional/Local	
Cape Cod Commission	Development of Regional Impact (DRI) Review
Martha’s Vineyard Commission	DRI Review
Falmouth and/or Bourne Planning & Zoning Board(s)	Local Planning/Zoning Approval(s) (if needed)
Falmouth and/or Bourne Conservation Commission(s)	Notice(s) of Intent and Order(s) of Conditions (Massachusetts Wetlands Protection Act and municipal wetland non-zoning bylaws)
Edgartown, Oak Bluffs, Tisbury and/or Nantucket Conservation Commissions	Notice(s) of Intent and Order(s) of Conditions (Massachusetts Wetlands Protection Act and municipal wetland non-zoning bylaws) for offshore route (if needed as dictated by final offshore route)
Falmouth and/or Bourne Department of Public Works (DPW), Board of Selectmen, and/or Town Council	Street Opening Permits/Grants of Location

EXHIBIT C**PROGRESS REPORTS**

Each Progress Report after the initial report shall include a redline against the previous quarter's report and shall include the following items:

1. A brief Facility description.
2. The indicative site plan of the Facility.
3. A description of any changes to the Facility or site plan.
4. A bar chart schedule showing progress on achieving each Critical Milestone, including progress on achieving the Commercial Operation Date.
5. A PERT or GANTT chart showing the critical path schedule of major items and activities regarding the development, construction and startup of the Facility.
6. A summary of major activities during the previous quarter.
7. A description of major activities scheduled for the current quarter.
8. A description of the progress on achieving each Critical Milestone.
9. A description of issues that have adversely impacted or could reasonably be expected to adversely impact achievement of any Critical Milestone, including a description of any events that have resulted in or could reasonably be expected to result in delays.

The Parties intend that, within five (5) to ten (10) days after each Progress Report is delivered to Buyer, a telephone call will be set up during business hours and upon reasonable notice to Seller to permit Buyer and its advisors and consultants to discuss such report with Seller and its advisors and consultants. Consistent with Section 7.2(k) of this Agreement, the intent of both the Progress Reports and the telephone calls will be to provide Buyer with accurate, timely and reasonably detailed information, when taken as a whole, regarding the status and progress of, and any major problems associated with, the development and construction of the Facility as of the date furnished.

EXHIBIT D

PRODUCTS AND PRICING

The Price for Buyer’s Percentage Entitlement of Delivered Products in nominal dollars shall be as follows:

(a) Product Price - Commencing on the Commercial Operation Date, the Price per MWh for the Products shall be equal to \$77.76 per MWh, and the Adjusted Price per MWh for the Products shall be equal to \$73.87 per MWh.

(b) Price Adjustment for ITC Increase – If as a result of either the Further Consolidated Appropriations Act, 2020 or a change in Law affecting the ITC that occurs prior to the Commercial Operation Date, Seller is able to qualify for an ITC that is in excess of twelve percent (12%) of the Seller’s eligible basis, then the Price and the Adjusted Price for Buyer’s Percentage Entitlement of Delivered Products in nominal dollars shall be as set forth below; provided, however, that, Seller shall maximize the ITC for which it qualifies to the extent permitted under applicable Law and if, as a result of a change in the requirements for eligibility to qualify for an ITC, Seller cannot qualify for the increased ITC, then neither the Price nor the Adjusted Price shall be reduced or otherwise affected.

The ITC percentage for which Seller qualifies:	Price (\$/MWh)	Adjusted Price (\$/MWh)
13%	\$77.34	\$73.47
14%	\$76.93	\$73.08
15%	\$76.51	\$72.68
16%	\$76.09	\$72.29
17%	\$75.68	\$71.89
18%	\$75.26	\$71.50
19%	\$74.84	\$71.10
20%	\$74.43	\$70.70
21%	\$74.01	\$70.31
22%	\$73.59	\$69.91
23%	\$73.18	\$69.52
24%	\$72.76	\$69.12
25%	\$72.34	\$68.72
26%	\$71.93	\$68.33
27%	\$71.51	\$67.93
28%	\$71.09	\$67.54
29%	\$70.68	\$67.14
30%	\$70.26	\$66.75

If the change in Law affecting the ITC (including for these purposes the Further Consolidated Appropriations Act, 2020) occurs prior to the Commercial Operation Date but the implementing regulations are adopted after the Commercial Operation Date, then the provisions for the adjustment of the Price and Adjusted Price will occur upon the adoption of the

implementing regulations, and to the extent the Price and Adjusted Price are reduced, Seller shall give Buyer a credit against payments due from Buyer under this Agreement equal to the amount of any overpayment by Buyer between the Commercial Operation Date and the adoption of the implementing regulations.

In the event the increased ITC for which Seller qualifies is not a whole number percentage, the adjustment to the Price and the Adjusted Price shall be interpolated based on the Price and Adjusted Price of the two nearest whole number percentages.

Notwithstanding any other provision of this Agreement, the Price per MWh for the Products shall never under any circumstances exceed \$77.76 per MWh, and the Adjusted Price per MWh shall never under any circumstances exceed \$73.87 per MWh.

(c) Allocated Price - The Price will be allocated between Energy and RECs as follows:

(i) Energy = The \$/MWh price of Energy for the applicable month shall be equal to the weighted average of the Real-Time and Day-Ahead Energy Market LMPs in that month (also on a \$/MWh basis) for the Node on the Pool Transmission Facilities to which the Facility is interconnected, consistent with the Internal Bilateral Transactions for such month under Section 4.2(a) of the Agreement.

(ii) RECs = The Price less the Energy allocation determined above for the applicable billing period, expressed in \$/MWh.

(d) Negative LMP Periods - If the market price at the Delivery Point in the Real-Time Energy Market or the Day-Ahead Energy Market, as applicable, for Energy Delivered by Seller is negative in any hour, the payment to Seller for deliveries of Energy shall be reduced by the difference between the absolute value of such hourly LMP at the Delivery Point and \$0.00 per MWh for that Energy for each such hour. Each monthly invoice shall reflect a reduction for all hours in the applicable month in which the applicable LMP for the Energy at the Delivery Point is less than \$0.00 per MWh.

Examples. If delivered Energy equals 1 MWh and Price equals \$50.00/MWh:

LMP at the Delivery Point equals (or is greater than) \$0.00/MWh
 Buyer payment of Price to Seller \$50.00
 Seller credit/reimbursement for negative LMP to Buyer \$0.00
 Net Result: Buyer pays Seller \$50 for that hour

LMP at the Delivery Point equals -\$150.00/MWh
 Buyer payment of Price to Seller \$50.00
 Seller credit/reimbursement for negative LMP to Buyer \$150.00
 Net Result: Seller credits or reimburses Buyer \$100 for that hour

EXHIBIT E**RELATED TRANSMISSION FACILITIES**

The following anticipated Related Transmission Facilities are also part of the Shared Equipment, subject to further design, from the high side of the step-up transformer at the offshore substation platform, inclusive of the following

Offshore Substation Platform

- Three 275 kV shunt reactors
- Three 275 kV busses with all applicable breakers, switches, protection, controls and communication equipment
- Three 66 kV to 275 kV step-up transformers

Offshore Export Cables

- Three 275 kV export cables (including the portions thereof that are onshore and interconnect with the onshore substation described below)

Onshore Export Cable

- A new 345 kV transmission line from the onshore substation to the proposed new Bourne 345 kV switching station that connects to NSTAR Electric Company 345 kV lines 322 and 342 near Bourne, Massachusetts. The 345 kV transmission line will be on new pole structures with foundations

Onshore Substation

- Three 275 kV to 345 kV transformers, with associated equipment and protection
- Power factor correction equipment, voltage, and frequency control equipment
- One 345 kV bus with all applicable breakers, switches, protection, controls and communication equipment
- Control house, which will house all battery banks and relay control panels, and SCADA equipment
- All required station service equipment such as transformer and transfer switches

Switching Station

The proposed new Bourne 345 kV switching station that connects to NSTAR Electric Company 345 kV lines 322 and 342 near Bourne, Massachusetts. The switching station will be a breaker and a half configuration, which will include the following:

- Three bays, each of which will include all applicable breakers, switches, protection, controls and communication equipment
- Control house, which will house all battery banks and relay control panels, and SCADA equipment
- All required station service equipment as needed by the utility and ISO-NE
- Dead end transmission line termination structures for intercepting the 345 kV lines

EXHIBIT F

REQUIRED NETWORK UPGRADES

Those Network Upgrades determined by ISO-NE as provided in Section 3.7 and any other Network Upgrades required for Seller to perform its obligations under this Agreement. As contemplated by Section 3.3(f), within thirty (30) days after the Network Upgrades are determined by ISO-NE as provided in Section 3.7, Seller shall provide Buyer with an updated version of this Exhibit F solely to reflect such Network Upgrades and any other Network Upgrades required for Seller to perform its obligations under this Agreement.

EXHIBIT G

METERING PROCESS

The electric “energy,” as such term is defined in the ISO-NE Tariff, generated in any hour (or shorter settlement period applicable under the ISO-NE Rules) (the “**Settlement Period**”) by the Facility, the Other Facility and the Additional Facilities as measured in MWh in Eastern Prevailing Time, less such facility’s station service use, generator lead losses and transformer losses, will be allocated among the Facility, the Other Facility and Additional Facilities, and attributed to Energy being purchased by Buyer hereunder and under the Phase II Mayflower Wind Power Purchase Agreement, as follows:

FM = the sum of the volumes measured at the output of the turbines included in the Facility over the relevant Settlement Period

OFM = the sum of the volumes measured at the output of the turbines included in the Other Facility over the relevant Settlement Period

AFM = the sum of the volumes measured at the output of the turbines included in the Additional Facilities over the relevant Settlement Period

$$\text{Facility Volume Ratio (FVR)} = \frac{FM}{FM + OFM + AFM}$$

$$\text{Other Facility Volume Ratio (OFVR)} = \frac{OFM}{FM + OFM + AFM}$$

The combined energy of the Facility, the Other Facility and the Additional Facilities during each Settlement Period (“E”), as measured by the Meter(s) at the Delivery Point, will be allocated between the Facility and the Other Facility as follows:

Energy allocated to the Facility (“FE”) = E x FVR

Energy allocated to the Other Facility = E x OFVR

The Energy (and associated RECs) to be purchased by Buyer under this Agreement during any Settlement Period shall be determined by the following formula:

(FE – TE – EE – ACPE) x BPE, where

“FE” is the Energy allocated to the Facility for such Settlement Period, as described above

“TE” is any Energy generated during the Settlement Period, as measured by the Meter(s) at the Delivery Point, when the Settlement Period occurs during the Test Period with respect to the Facility

“EE” is any Energy generated during the Settlement Period, as measured by the Meter(s) at the Delivery Point, in excess of the Contract Maximum Amount with respect to the Facility

“ACPE” is Energy generated during the Settlement Period, as measured by the Meter(s) at the Delivery Point, by portions of the Facility that are completed during the Additional Construction Period and generated prior to the delivery of the Additional Construction Certificates

“BPE” is the Buyer’s Percentage Entitlement

Each Internal Bilateral Transaction submitted by Seller under Section 4.2(a) will be consistent with this Exhibit G, and any TE, EE or ACPE calculations will be based on SCADA data produced by the Facility, the Other Facility and the Additional Facilities, as applicable. Seller will provide such SCADA data for the Facility, the Other Facility and the Additional Facilities with each invoice delivered to Buyer under the Agreement.

The following schematic shows the metering process described in this Exhibit G:

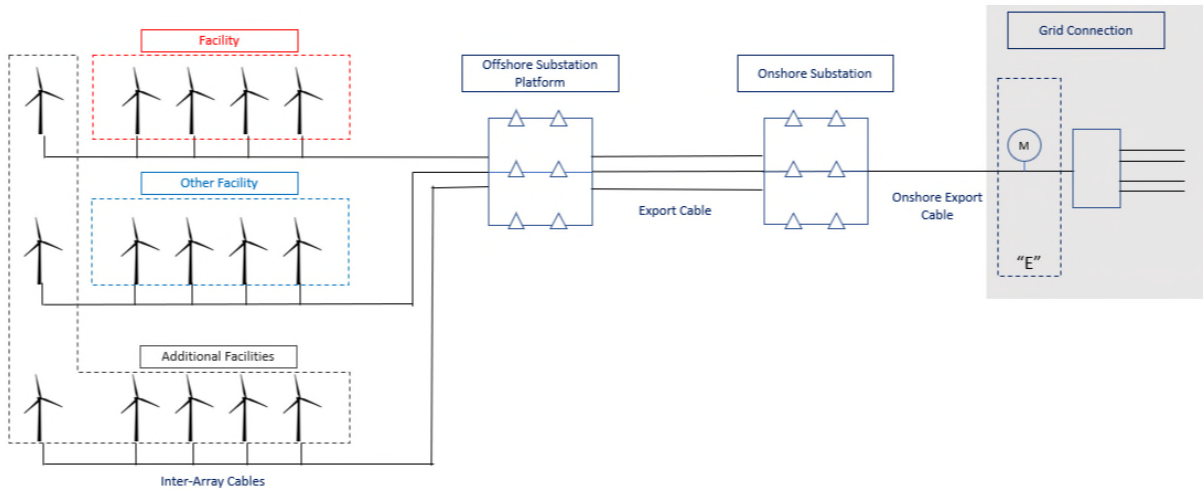

EXHIBIT H

FORM OF COMMITMENT AGREEMENT

Voluntary Agreement Commitment Agreement

This Voluntary Agreement Commitment Agreement (“Commitment Agreement”), dated as of January 10, 2020, is made and entered into by Mayflower Wind Energy LLC (“Mayflower”) for the benefit of Massachusetts Electric Company and Nantucket Electric Company d/b/a National Grid (“Distribution Company”). Mayflower and Distribution Company are hereinafter sometimes also referred to collectively as the “Parties.”

WITNESSETH

WHEREAS, Mayflower has been conditionally selected by Distribution Company as a winning bidder under the Request for Proposals for Long-Term Contracts for Offshore Wind Energy Projects, dated May 23, 2019, as revised August 7, 2019 (the “RFP”);

WHEREAS, concurrently with the execution and delivery of this Commitment Agreement, Mayflower has entered into two power purchase agreements with Distribution Company (“PPAs”);

WHEREAS, as part of its performance under the PPAs, Mayflower intends to construct, or cause to be constructed, Interconnection Customer Interconnection Facilities, as defined herein;

WHEREAS, Distribution Company and Mayflower desire to reasonably minimize obstacles to the ability of future offshore wind energy developers to deliver their energy and capacity to the onshore transmission system, possibly via interconnection with Mayflower’s ICIF;

NOW, THEREFORE, in consideration of the foregoing and its conditional selection under the RFP, and other consideration the receipt and sufficiency of which are hereby acknowledged, and intending to be legally bound hereby, Mayflower hereby agrees as follows:

1. Definitions

The following definitions shall apply to the provisions of this Commitment Agreement:

- A. Interconnection Customer’s Interconnection Facilities (“ICIF”) means all facilities and equipment located between Mayflower’s offshore wind energy generation facilities collector system step-up transformers and the point of change of ownership at the onshore interconnection, including any modification, addition, or upgrades to such facilities and equipment, which facilities and equipment are constructed to physically and electrically interconnect Mayflower’s offshore wind energy generation facilities to the onshore transmission system.
- B. “Third-Party Offshore Wind Developer” means any entity (other than Mayflower) developing offshore wind energy generation or delivery facilities and seeking

interconnection to and/or delivery service on Mayflower's ICIF pursuant to this Commitment Agreement.

- C. "Voluntary Agreement" means a voluntary agreement as contemplated in Federal Energy Regulatory Commission ("FERC") Order No. 807¹, PP 117-18 to be entered into if a Third-Party Offshore Wind Developer requests studies and potential expansion of Mayflower's ICIF to accommodate third party interconnection and delivery service, without the need for said third party to pursue its rights in the first instance via Sections 210, 211, and 212 of the Federal Power Act.
2. In the event one or more Third-Party Offshore Wind Developers request interconnection to and/or delivery service on Mayflower's ICIF, Mayflower will study the requested interconnection and/or delivery service, provided that the Third-Party Offshore Wind Developer(s) agrees to pay the cost of such studies.
 3. Mayflower will negotiate in good faith and use commercially reasonable best efforts to conclude a Voluntary Agreement with any such Third-Party Offshore Wind Developer regarding expansion of, interconnection to, and delivery service over Mayflower's ICIF to accommodate the Third-Party Offshore Wind Developer's request.
 4. The Voluntary Agreement will incorporate interconnection and other provisions at least as favorable to said Third-Party Offshore Wind Developers as the provisions of ISO New England Inc. ("ISO-NE") Open Access Transmission Tariff Schedules 22 and 23 are to requesters of interconnection service seeking to connect to facilities subject to the ISO-NE interconnection procedures in those schedules. Mayflower will respond to reasonable requests from ISO-NE or Third-Party Offshore Wind Developers for information deemed necessary to support an ISO-NE interconnection request by Third-Party Offshore Wind Developers on the ISO-NE system.
 5. If, after good faith attempts to conclude a Voluntary Agreement using commercially reasonable best efforts, Mayflower and Third-Party Offshore Wind Developer are unable to conclude such a Voluntary Agreement, Mayflower shall be relieved of any further obligations as to that Third-Party Offshore Wind Developer under this Commitment Agreement, and in such event, nothing herein shall diminish Third-Party Offshore Wind Developer's rights independent of this Commitment Agreement to request relief from FERC.
 6. Third-Party Offshore Wind Developer may at any time exercise its rights under Federal Power Act Sections 206 or Sections 210, 211, and 212 that exist independent of this Commitment Agreement to file with FERC requesting an order requiring interconnection and/or delivery service on Mayflower's ICIF. In the event that the Third-Party Offshore Wind Developer exercises such rights, Mayflower will have no further obligations to such Third-Party Offshore Wind Developer under this Commitment Agreement.

¹ *Open Access and Priority Rights on Interconnection Customer's Interconnection Facilities*, 150 FERC ¶ 61,211 (2015) ("Order No. 807").

7. If an entity other than Mayflower obtains ownership or successor rights in Mayflower's ICIF, Mayflower will ensure that such other entity as well as Mayflower will be bound by the terms and conditions of this Commitment Agreement.

8. This Commitment Agreement is not intended to, and does not create any rights or obligations in either of the Parties or any other entity except for those explicitly identified herein, nor does this Commitment Agreement affect Mayflower's rights under FERC's regulations at 18 C.F.R. §§ 35.28(d)(2)(ii)(A)-(B) with respect to excess or unused capacity on Mayflower's ICIF. Breach of or default on this Commitment Agreement will not operate to create a breach of or default on either of the PPAs, unless the conduct producing the breach or default of this Commitment Agreement would independently create a breach or default of such PPA.

IN WITNESS WHEREOF, Mayflower has caused this Commitment Agreement to be duly executed on its behalf as of the date first above written.

MAYFLOWER WIND ENERGY LLC

By: _____
Name:
Title: