

~~APPENDIX C 2 EVERSOURCE UNITIL PPA Facility 1
EXECUTION VERSION~~

Formatted: Right

Formatted: No underline

~~Draft 5/10/17~~

~~DRAFT¹~~

~~OFFSHORE WIND GENERATION UNIT~~

~~POWER PURCHASE AGREEMENT~~

~~BETWEEN~~

~~{
Buyer}~~

~~NSTAR ELECTRIC COMPANY d/b/a EVERSOURCE ENERGY~~

~~AND~~

~~{
Seller}~~

~~A VINAYARD WIND LLC~~

~~Dated as of {
}, 201~~7~~18~~

¹~~This draft Offshore Wind Power Purchase Agreement is intended to provide a general description of the terms to which the electric distribution companies are willing to agree. The final Agreement will be subject to negotiations with the individual electric distribution companies and will be customized to address the relevant circumstances, such as different generating technologies and purchases of an entitlement to all RECs produced by the generating facility, as well as rules specific to purchases and sales from adjacent control areas, as applicable. Accordingly, certain provisions in the final Agreement may differ from this draft Agreement.~~

TABLE OF CONTENTS

	<u>Page</u>
1. DEFINITIONS.....	1
2. EFFECTIVE DATE; TERM.....	15
2.1 Effective Date	15
2.2 Term.....	15
3. FACILITY DEVELOPMENT AND OPERATION	15
3.1 Critical Milestones	15
3.2 Delay Damages	16
3.3 Construction and Changes in Capacity	17
3.4 Commercial Operation.....	18
3.5 Operation of the Facility	20
3.6 Interconnection and Delivery Services	23
4. DELIVERY OF PRODUCTS.....	23
4.1 Obligation to Sell and Purchase Products.....	23
4.2 Scheduling and Delivery.....	24
4.3 Failure of Seller to Deliver Products	25
4.4 Failure by Buyer to Accept Delivery of Products.....	25
4.5 Delivery Point	25
4.6 Metering.....	25
4.7 RECs	27
4.8 Deliveries During Test Period	30
5. PRICE AND PAYMENTS FOR PRODUCTS	30
5.1 Price for Products.....	30
5.2 Payment and Netting.....	31
5.3 Interest on Late Payment or Refund	32
5.4 Taxes, Fees and Levies	32
6. SECURITY FOR PERFORMANCE.....	33
6.1 Seller’s Support.....	33
6.2 Cash Deposits.....	34
6.3 Return of Credit Support.....	34
6.4 Buyer’s Rights and Remedies.....	34
7. REPRESENTATIONS, WARRANTIES, COVENANTS AND ACKNOWLEDGEMENTS.....	40

TABLE OF CONTENTS (CONT.)

	<u>Page</u>
7.1 Representations and Warranties of Buyer.....	40
7.2 Representations and Warranties of Seller.....	41
7.3 Continuing Nature of Representations and Warranties.....	44
8. REGULATORY APPROVAL.....	44
8.1 Receipt of Regulatory Approval.....	44
8.2 Related Transmission Approvals.....	44
9. BREACHES; REMEDIES.....	44
9.1 Events of Default by Either Party.....	44
9.2 Events of Default by Seller.....	45
9.3 Remedies.....	46
10. FORCE MAJEURE.....	50
10.1 Force Majeure.....	50
11. DISPUTE RESOLUTION.....	51
11.1 Dispute Resolution.....	51
11.2 Allocation of Dispute Costs.....	51
11.3 Consent to Jurisdiction.....	52
11.4 Waiver of Jury Trial and Inconvenient Forum Claim.....	52
12. CONFIDENTIALITY.....	52
12.1 Nondisclosure.....	52
12.2 Public Statements.....	53
13. INDEMNIFICATION.....	53
13.1 Indemnification Obligations.....	53
13.2 Failure to Defend.....	53
14. ASSIGNMENT AND CHANGE OF CONTROL.....	53
14.1 Prohibition on Assignments.....	53
14.2 Permitted Assignment by Seller.....	53
14.3 Change in Control over Seller.....	53
14.4 Permitted Assignment by Buyer.....	54
14.5 Prohibited Assignments.....	54
15. TITLE; RISK OF LOSS.....	54
16. AUDIT.....	54
16.1 Audit.....	54
16.2 Access to Financial Information.....	54

TABLE OF CONTENTS (CONT.)

	<u>Page</u>
17. NOTICES.....	55
18. WAIVER AND MODIFICATION.....	55
19. INTERPRETATION.....	55
19.1 Choice of Law.....	55
19.2 Headings.....	55
19.3 Forward Contract.....	56
19.4 Standard of Review.....	56
19.5 Change in ISO-NE Rules and Practices.....	56
19.6 Dodd-Frank Act Representations.....	56
19.7 Change in Law or Buyer’s Accounting Treatment, Subsequent Judicial or Regulatory Action.....	57
20. COUNTERPARTS; FACSIMILE SIGNATURES.....	58
21. NO DUTY TO THIRD PARTIES.....	58
22. SEVERABILITY.....	58
23. INDEPENDENT CONTRACTOR.....	58
24. ENTIRE AGREEMENT.....	59
1. DEFINITIONS.....	1
2. EFFECTIVE DATE; TERM.....	14
2.1 Effective Date.....	14
2.2 Term.....	14
3. FACILITY DEVELOPMENT AND OPERATION.....	15
3.1 Critical Milestones.....	15
3.2 Delay Damages.....	16
3.3 Construction and Changes in Capacity.....	17
3.4 Commercial Operation.....	18
3.5 Operation of the Facility.....	22
3.6 Interconnection and Delivery Services.....	26
3.7 Forward Capacity Market Participation and Network Upgrades.....	26
4. DELIVERY OF PRODUCTS.....	28
4.1 Obligation to Sell and Purchase Products.....	28
4.2 Scheduling and Delivery.....	29
4.3 Failure of Seller to Deliver Products.....	30
4.4 Failure by Buyer to Accept Delivery of Products.....	30

TABLE OF CONTENTS (CONT.)

	<u>Page</u>
4.5 Delivery Point	30
4.6 Metering	31
4.7 RECs	32
4.8 Production During Test Period	36
5. PRICE AND PAYMENTS FOR PRODUCTS	36
5.1 Price for Products	36
5.2 Payment and Netting	36
5.3 Interest on Late Payment or Refund	38
5.4 Taxes, Fees and Levies	38
6. SECURITY FOR PERFORMANCE.....	38
6.1 Seller’s Support.....	38
6.2 Cash Deposits.....	39
6.3 Return of Credit Support.....	39
6.4 Buyer’s Rights and Remedies	40
7. REPRESENTATIONS, WARRANTIES, COVENANTS AND ACKNOWLEDGEMENTS.....	40
7.1 Representations and Warranties of Buyer.....	40
7.2 Representations and Warranties of Seller	41
7.3 Continuing Nature of Representations and Warranties	44
8. REGULATORY APPROVAL	44
8.1 Receipt of Regulatory Approval	44
9. BREACHES; REMEDIES	45
9.1 Events of Default by Either Party	45
9.2 Events of Default by Seller	46
9.3 Remedies.....	48
10. FORCE MAJEURE.....	52
10.1 Force Majeure	52
11. DISPUTE RESOLUTION.....	53
11.1 Dispute Resolution.....	53
11.2 Allocation of Dispute Costs	53
11.3 Consent to Jurisdiction.....	53
11.4 Waiver of Jury Trial and Inconvenient Forum Claim.....	53
12. CONFIDENTIALITY.....	54

TABLE OF CONTENTS (CONT.)

	<u>Page</u>
<u>12.1 Nondisclosure</u>	<u>54</u>
<u>12.2 Public Statements.....</u>	<u>54</u>
<u>13. INDEMNIFICATION.....</u>	<u>54</u>
<u>13.1 Indemnification Obligations</u>	<u>54</u>
<u>13.2 Notice of Claims; Procedure.....</u>	<u>55</u>
<u>13.3 Failure to Defend</u>	<u>55</u>
<u>13.4 Contributory Negligence.....</u>	<u>55</u>
<u>13.5 Survival; Limitations</u>	<u>55</u>
<u>14. ASSIGNMENT AND CHANGE OF CONTROL</u>	<u>55</u>
<u>14.1 Prohibition on Assignments.....</u>	<u>55</u>
<u>14.2 Permitted Assignment by Seller.....</u>	<u>56</u>
<u>14.3 Change in Control over Seller.....</u>	<u>56</u>
<u>14.4 Permitted Assignment by Buyer</u>	<u>56</u>
<u>14.5 Prohibited Assignments</u>	<u>57</u>
<u>15. TITLE; RISK OF LOSS</u>	<u>57</u>
<u>16. AUDIT</u>	<u>57</u>
<u>16.1 Audit</u>	<u>57</u>
<u>16.2 Access to Financial Information</u>	<u>57</u>
<u>17. NOTICES.....</u>	<u>57</u>
<u>18. WAIVER AND MODIFICATION.....</u>	<u>58</u>
<u>19. INTERPRETATION.....</u>	<u>58</u>
<u>19.1 Choice of Law</u>	<u>58</u>
<u>19.2 Headings</u>	<u>58</u>
<u>19.3 Forward Contract</u>	<u>58</u>
<u>19.4 Standard of Review</u>	<u>59</u>
<u>19.5 Change in ISO-NE Rules and Practices.....</u>	<u>59</u>
<u>19.6 Dodd Frank Act Representations</u>	<u>59</u>
<u>19.7 Change in Law or Buyer’s Accounting Treatment, Subsequent Judicial or Regulatory Action.....</u>	<u>60</u>
<u>20. COUNTERPARTS; FACSIMILE SIGNATURES</u>	<u>61</u>
<u>21. NO DUTY TO THIRD PARTIES</u>	<u>61</u>
<u>22. SEVERABILITY</u>	<u>61</u>
<u>23. INDEPENDENT CONTRACTOR.....</u>	<u>61</u>

TABLE OF CONTENTS (CONT.)

	<u>Page</u>
<u>24. ENTIRE AGREEMENT.....</u>	<u>62</u>

Exhibits

Exhibit A	Description of Facility
Exhibit B	Seller's Critical Milestones – Permits and Real Estate Rights
Exhibit C	Form of Progress Report
Exhibit D	Products and Pricing
Exhibit E	Related Transmission Facilities
	<u>Metering Process</u>
<u>Exhibit F</u>	<u>Intentionally Omitted</u>
<u>Exhibit G</u>	<u>Insurance</u>

Draft
 5-10-2017

POWER PURCHASE AGREEMENT

This **POWER PURCHASE AGREEMENT** (as amended from time to time in accordance with the terms hereof, this "**Agreement**") is entered into as of ~~_____~~, ~~2017~~ July 31, 2018 (the "**Effective Date**"), by and between ~~_____~~, NSTAR ELECTRIC COMPANY d/b/a _____ ~~EVERSOURCE ENERGY, a Massachusetts corporation~~ ("**Buyer**"), and ~~_____~~, a ~~_____~~ VINEYARD WIND LLC, a Delaware limited liability company ("**Seller**"). Buyer and Seller are individually referred to herein as a "**Party**" and are collectively referred to herein as the "**Parties**".

WHEREAS, Seller is developing a portion of the ~~_____~~ Vineyard Wind offshore wind electric generation facility to be located in ~~_____~~, on the Outer Continental Shelf in Bureau of Ocean Energy Management Lease OCS-A 0501 area, which is more fully described in Exhibit A hereto (the "**Facility**"), from which the Buyer's Percentage Entitlement of the Products (as defined below) is to be delivered to Buyer pursuant to the terms of this Agreement; and

WHEREAS, the Facility is, and shall qualify as a RPS Class I Renewable Generation Unit in the Commonwealth of Massachusetts and which is expected to be in commercial operation by ~~_____~~ January 15, 2022; and

WHEREAS, pursuant to Section 83C of the Green Communities Act as added by Chapter 188 of the Acts of 2016, An Act to Promote Energy Diversity ("**Section 83C**"), Buyer is authorized to enter into certain long-term contracts for the purchase of energy or energy and renewable energy certificates from offshore wind generators meeting the requirements of Section 83C; and

WHEREAS, Buyer and Seller desire to enter into this Agreement whereby Buyer shall purchase from Seller certain ~~Energy~~ ~~Energy and RECs~~ RECs (each as defined herein) generated by or associated with the Facility;

NOW, THEREFORE, in consideration of the premises and of the mutual agreements contained herein, and for other good and valuable consideration, the receipt and sufficiency of which are hereby acknowledged, the Parties hereby agree as follows:

1. DEFINITIONS

In addition to terms defined in the recitals hereto, the following terms shall have the meanings set forth below. Any capitalized terms used in this Agreement and not defined herein shall have the same meaning as ascribed to such terms under the ISO-NE Practices and ISO-NE Rules.

"**Actual Facility Size**" shall mean the actual nameplate capacity of the Facility, as built, and as certified by an Independent Engineer, as provided in Section 3.4(b)(~~iiii~~ xi), as may be adjusted pursuant to Section 3.4 and reflected in a notice exercising the Capacity Downsize Option or the Additional Construction IE Certificate, as applicable.

“Additional Construction IE Certificate” shall have the meaning set forth in Section 3.4(e).

“Additional Construction Period” shall have the meaning set forth in Section 3.4(d).

“Additional RECs” shall have the meaning in Section 4.7(c).

“Adverse Determination” shall have the meaning set forth in Section 19.7.

“Affiliate” shall mean, with respect to any Person, any other Person that directly or indirectly through one or more intermediaries Controls, is Controlled by, or is under common Control with, such first Person.

“Agreement” shall have the meaning set forth in the first paragraph of this Agreement.

“Alternative Compliance Payment Rate” shall mean the rate per MWh paid by electricity suppliers under applicable Law for failure to supply RECs in accordance with the RPS.

“Business Day” ~~means~~shall mean a day on which Federal Reserve member banks in New York, New York are open for business; and a Business Day shall start at 8:00 a.m. and end at 5:00 p.m. Eastern Prevailing Time.

“Buyer’s Percentage Entitlement” shall mean Buyer’s rights to ~~{~~52.85 percent ~~(~~41%~~)(52.85%)~~ of the Products. Buyer’s Percentage Entitlement may be adjusted in accordance with Section 3.3(c).

“Buyer’s Taxes” shall have the meaning set forth in Section 5.4(a) hereof.

“Capacity Deficiency” ~~means~~shall mean, at the Commercial Operation Date the amount (expressed in MW), if any, by which the Actual Facility Size is less than the proposed nameplate capacity of the Facility as set forth in Exhibit A.

“Capacity Deficiency Damages” shall have the meaning set forth in Section 3.4(g) hereof.

“Capacity Downsize Option” shall have the meaning set forth in Section 3.4(c).

“Cash” shall mean U.S. dollars held by or on behalf of a Party as Posted Collateral hereunder.

“Catastrophic Failure” shall mean the catastrophic failure of any piece of the Key Equipment where such failed Key Equipment has been maintained in accordance with Good Utility Practice and all other requirements of this Agreement and such failure cannot reasonably be expected, in accordance with Good Utility Practice, to be corrected with the repair, refurbishment or replacement of such failed Key Equipment within three (3) months of the occurrence of such failure using commercially reasonable efforts.

“Catastrophic Failure Period” shall mean (i) eighteen (18) consecutive months if the Catastrophic Failure includes a Catastrophic Failure of the generator step-up transformers at the offshore substation or the transformers at the onshore substation, and (ii) twelve (12) consecutive months if the Catastrophic Failure does not include a Catastrophic Failure of those transformers at the offshore substation.

“Certificate” shall mean an electronic certificate created pursuant to the GIS Operating Rules or any successor thereto to represent certain Environmental Attributes of each MWh of Energy generated within the ISO-NE control area and the generation attributes of certain Energy imported into the ISO-NE control area.

“COD Network Upgrades” shall mean upgrades to the Pool Transmission Facilities and the Transmission Provider’s transmission and distribution systems, as determined and identified in the interconnection study approved in connection with construction of the Facility, necessary for Delivery of the Energy to the Delivery Point; provided, however, that in no event shall COD Network Upgrades include the additional upgrades necessary to achieve the summer Seasonal Claimed Capability and winter Seasonal Claimed Capability described in Section 3.7(a) of this Agreement.

“Commercial Operation Date” shall mean the date on which the conditions set forth in Section 3.4(b) have been satisfied, as set out in a written notice from Seller to Buyer.

“Contract Maximum Amount” shall mean ~~1~~211.40 MWh per hour of Energy and a corresponding portion of all other Products, as may be adjusted in accordance with Section 3.3(b).

“Contract Year” shall mean the twelve (12) consecutive calendar months starting on the first day of the calendar month following the Commercial Operation Date and each subsequent twelve (12) consecutive calendar month period; provided that the first Contract Year shall include the days in the prior month in which the Commercial Operation Date occurred.

“Control” shall mean the possession, directly or indirectly, of the power to direct or cause the direction of the management and policies of a Person, whether through the ownership of voting securities, by contract or otherwise.

“Cover Damages” shall mean, with respect to any Delivery Failure, an amount equal to (a) the positive net amount, if any, by which the Replacement Price exceeds the applicable Price that would have been paid for the Products pursuant to Section 5.1 hereof, multiplied by the quantity of that Delivery Failure, plus (b) any other costs incurred by Buyer in purchasing Replacement Energy and/or Replacement RECs due to that Delivery Failure, plus (c) any applicable penalties and other costs assessed by ISO-NE or any other Person against Buyer as a result of that Delivery Failure, plus (d) any other ~~transaction and other out-of-pocket costs and losses~~ incurred by Buyer ~~as a result of~~ that ~~Buyer would not have incurred but for the~~ Delivery Failure. Buyer shall provide a statement for the applicable period explaining in reasonable detail the calculation of any Cover Damages.

~~“**Credit Support**” shall mean collateral in the form of (a) ~~cash~~Cash or (b) a ~~letter~~Letter of ~~credit~~Credit issued by a Qualified Bank in a form reasonably acceptable to the Buyer.~~

“**Critical Milestones**” shall have the meaning set forth in Section 3.1 hereof.

~~“**Day Ahead Energy Market**” shall have the meaning set forth in the ISO-NE Rules.~~

“**Default**” shall mean any event or condition which, with the giving of notice or passage of time or both, could become an Event of Default.

“**Defaulting Party**” shall mean the Party with respect to which a Default or Event of Default has occurred.

“**Delay Damages**” shall mean the damages assessed pursuant to Section 3.2(a) hereof.

“**Deliver**” or “**Delivery**” shall mean with respect to (i) Energy, to supply Energy into Buyer’s ISO-NE account at the Delivery Point in accordance with the terms of this Agreement and the ISO-NE Rules, and (ii) RECs, to supply RECs in accordance with Section 4.7(e).

“**Delivery Failure**” shall have the meaning set forth in Section 4.3 hereof.

“**Delivery Point**” shall mean the specific location on the Pool Transmission Facilities where Seller shall Deliver its Energy to Buyer, as set forth in Exhibit A hereto.

“**Development Period Security**” shall have the meaning set forth in Section 6.1(a~~+~~) hereof.

“**Dispute**” shall have the meaning set forth in Section 11.1 hereof.

~~“**DOER**” shall mean the Massachusetts Department of Energy Resources and its successors.~~

“**Eastern Prevailing Time**” shall mean either Eastern Standard Time or Eastern Daylight Savings Time, as in effect from time to time.

“**Effective Date**” shall have the meaning set forth in the first paragraph hereof.

“**Energy**” shall mean electric “energy,” as such term is defined in the ISO-NE Tariff, generated by the Facility as measured in MWh in Eastern Prevailing Time, less such Facility’s station service use, generator lead losses and transformer losses, which quantity for purposes of this Agreement will never be less than zero.

“**Environmental Attributes**” shall mean any and all generation attributes under the RPS and under any and all other international, federal, regional, state or other law, rule, regulation, bylaw, treaty or other intergovernmental compact, decision, administrative decision, program (including any voluntary compliance or membership program), competitive market or business method (including all credits, certificates, benefits, and

emission measurements, reductions, offsets and allowances related thereto) that are attributable, now or in the future, to Buyer's Percentage Entitlement to the favorable generation or environmental attributes of the Facility or the Products produced by the Facility, up to and including the Contract Maximum Amount, during the Services Term including Buyer's Percentage Entitlement to: (a) any such credits, certificates, benefits, offsets and allowances computed on the basis of the Facility's generation using renewable technology or displacement of fossil-fuel derived or other conventional energy generation; (b) any Certificates issued pursuant to the GIS in connection with Energy generated by the Facility; and (c) any voluntary emission reduction credits obtained or obtainable by Seller in connection with the generation of Energy by the Facility; provided, however, that Environmental Attributes shall not include: (i) any state or federal production tax credits; (ii) any state or federal investment tax credits or other tax credits associated with the construction or ownership of the Facility; or (iii) any state, federal or private grants, financing, guarantees or other credit support relating to the construction or ownership, operation or maintenance of the Facility or the output thereof.

"Event of Default" shall have the meaning set forth in Section 9.1 hereof and shall include the events and conditions described in Section 9.1 and Section 9.2 hereof.

"EWG" shall mean an exempt wholesale generator under 42 U.S.C. §§ 16451-16463, as amended from time to time, and FERC's implementing regulations thereunder.

"Expected Nameplate Capacity" shall mean the expected nameplate capacity of the Facility as set forth on Exhibit A, as may be revised pursuant to the terms of this Agreement.

"Facility" shall have the meaning set forth in the Recitals.

"FCM" shall mean the Forward Capacity Market described in the ISO-NE Tariff, which includes a mechanism for procuring capacity in the New England Control Area, or any successor thereto. ~~[Provision included to the extent the proposal contemplates an FCM commitment]~~

"Federal Funds Rate" shall mean the annualized interest rate for the applicable month as set forth in the statistical release designated as H.15, or any successor publication, published by the Board of Governors of the Federal Reserve System.

"FERC" shall mean the United States Federal Energy Regulatory Commission, and shall include its successors.

"Financial Closing Date" shall mean the date of the closing of the initial agreements for any Financing of the Facility and of an initial disbursement of funds under such agreements which are needed for construction of the Facility.

"Financing" shall mean any direct or indirect funding in connection with any development, bridge, construction, permanent debt or Tax Equity Transaction or refinancing for the Facility, including, without limitation, lease, inverted lease, sale, leaseback, partnership flip, monetization of tax benefits, back leverage financing, credit

derivative arrangements, indebtedness, whether secured or unsecured, loans, guarantees, notes, convertible debt, and bond issuances ~~adequate for the construction of the Facility~~.

“Force Majeure” shall have the meaning set forth in Section 10.1(a) hereof.

“Generation Unit” shall mean a facility that converts a fuel or an energy resource into electrical energy.

“GIS” shall mean the NEPOOL Generation Information System or any successor thereto, which includes a generation information database and certificate system, operated by NEPOOL, its designee or successor entity, that accounts for generation attributes of electricity generated or consumed within New England.

“GIS Operating Rules” ~~are~~ shall mean the NEPOOL Generation Information System Operating Rules effective as of the Effective Date, as amended, superseded, or restated from time to time.

“Good Utility Practice” shall mean compliance with all applicable ~~laws, codes, rules and regulations~~ Laws, all ISO-NE Rules and ISO-NE Practices, and any practices, methods and acts engaged in or approved by a significant portion of the electric industry in New England ~~during the relevant time period and by the offshore wind generation industry, as applicable, during the relevant time period, taking into account the technology of the equipment and the environment with respect to which these practices will be applied~~, or any of the practices, methods and acts which, in the exercise of reasonable judgment in light of the facts known at the time the decision is made, could have been expected to accomplish the desired result consistent with good business practices, reliability, safety and expedition. Good Utility Practice is not intended to be limited to the optimum practice, method or act to the exclusion of all others, but rather is intended to include acceptable practices, methods and acts generally accepted in the electric industry in New England ~~and by the offshore wind generation industry, as applicable, taking into account the technology of the equipment and the environment with respect to which these practices will be applied~~.

“Governmental Entity” shall mean any federal, state or local governmental agency, authority, department, instrumentality or regulatory body, and any court or tribunal, with jurisdiction over Seller, Buyer or the Facility.

“Guaranteed Commercial Operation Date” shall have the meaning set forth in Section 3.1(a)(iv)(~~v~~) hereof.

“I.3.9 Confirmation” refers to the ISO-NE Tariff Section I.3.9 pertaining to ISO-NE’s approval of proposed plans as specified therein.

“Independent Engineer” shall mean a licensed Professional Engineer with expertise in the development of renewable energy projects using the same renewable energy technology as the Facility, reasonably selected by and retained by Seller in order to determine the as-built nameplate capacity of the Facility as provided in Section 3.4(b)(~~xiii~~) hereof.

“Indirect Parent Entity” shall mean any direct or indirect owner of Seller.

“Interconnecting Utility” shall mean the utility (which may or may not be Buyer or an Affiliate of Buyer) providing interconnection service for the Facility to the Transmission System of that utility.

“Interconnection Agreement” shall mean an agreement between Seller and the Interconnecting Utility and ISO-NE, as applicable, regarding the interconnection of the Facility to the Transmission System of the Interconnecting Utility, as the same may be amended from time to time.

“Interconnection Point” shall have the meaning set forth in the Interconnection Agreement.

“Internal Bilateral Transaction” shall mean an Internal Bilateral for Market for Energy as defined in the ISO-NE Tariff.

“Investment Grade” shall mean, with respect to any Person, such Person having a rating for its senior long-term unsecured debt obligations of at least (a) “A-” by S&P and “A3” by Moody’s, if such entity is rated by both S&P and Moody’s or (b) “A-” by S&P or “A3” by Moody’s, if such entity is rated by either S&P or Moody’s but not both.

“ISO” or **“ISO-NE”** shall mean ISO New England Inc., the independent system operator established in accordance with the RTO arrangements for New England, or its successor.

“ISO-NE Practices” shall mean the ISO-NE practices and procedures for delivery and transmission of energy in effect from time to time and shall include, without limitation, applicable requirements of the NEPOOL Agreement, and any applicable successor practices and procedures.

“ISO-NE Rules” shall mean all rules and procedures adopted by NEPOOL, ISO-NE, or the RTO, and governing wholesale power markets and transmission in New England, as such rules may be amended from time to time, including but not limited to, the ISO-NE Tariff, the ISO-NE Operating Procedures (as defined in the ISO-NE Tariff), the ISO-NE Planning Procedures (as defined in the ISO-NE Tariff), the Transmission Operating Agreement (as defined in the ISO-NE Tariff), the ISO-NE Participants Agreement, the manuals, procedures and business process documents published by ISO-NE via its web site and/or by its e-mail distribution to appropriate NEPOOL participants and/or NEPOOL committees, as amended, superseded or restated from time to time.

“ISO-NE Tariff” shall mean ISO-NE’s Transmission, Markets and Services Tariff, FERC Electric Tariff No. 3, as amended, superseded or restated from time to time.

“ISO Settlement Market System” shall have the meaning as set forth in the ISO-NE Tariff.

“Key Equipment” shall mean the following pieces of equipment for the Facility: (a) the main power transformer, (b) the metal-clad switchgear, (c) the main circuit breaker, (d) the export cable, and (e) the offshore substation.

“Late Payment Rate” shall have the meaning set forth in Section 5.3 hereof.

“Law” shall mean all federal, state and local statutes, regulations, rules, orders, executive orders, decrees, policies, judicial decisions and notifications.

“Lender” shall mean a party providing Financing for the development ~~and~~ construction, or ownership of the Facility, or any refinancing of ~~that~~ Financing, ~~and receiving a security interest in the Facility~~, and shall include any assignee or transferee of such a party and any trustee, collateral agent or similar entity acting on behalf of such a party.

~~“Letter of Credit” shall mean an irrevocable, non-transferable, standby letter of credit, issued by a Qualified Bank utilizing a form acceptable to the Party in whose favor such letter of credit is issued. All costs relating to any Letter of Credit shall be for the account of the Party providing that Letter of Credit.~~

“Letter of Credit Default” shall have the meaning set forth in Section 9.2(b).

“Locational Marginal Price” or “LMP” shall have the meaning set forth in the ISO-NE Rules.

“Losses” shall have the meaning set forth in Section 13.1.

“Market Price” shall mean the price received by Buyer by selling the Energy into either the ISO-NE-administered Day-Ahead or Real-Time Markets, as applicable.

“MDPU” shall mean the Massachusetts Department of Public Utilities and its successors.

“MDPU Order” shall mean the MDPU’s order satisfying all of the requirements of the Regulatory Approval, except that such order may not be final and may remain subject to appeal or rehearing.

“Meters” shall have the meaning set forth in Section 4.6(a) hereof.

“Moody’s” shall mean Moody’s Investors Service, Inc., and any successor thereto.

“MW” shall mean a megawatt AC.

“MWh” shall mean a megawatt-hour (one MWh shall equal 1,000 kWh).

“NEPOOL” shall mean the New England Power Pool and any successor organization.

“NERC” shall mean the North American Electric Reliability Corporation and shall include any successor thereto.

“Network Upgrades” shall mean the COD Network Upgrades and those upgrades to the Pool Transmission Facilities and the Transmission Provider’s transmission and distribution systems, as determined and identified in the interconnection study approved in connection with construction of the Facility, necessary ~~for Delivery of the Energy to~~ achieve the Delivery Point, including those that are necessary for the Seller’s satisfaction of the obligations under summer Seasonal Claimed Capability and winter Seasonal Claimed Capability described in Section 3.7-4(a) of this Agreement.

“New England Control Area” shall have the meaning as set forth in the ISO-NE Tariff.

“Node” shall have the meaning set forth in ISO-NE Rules.

“Non-Defaulting Party” shall mean the Party with respect to which a Default or Event of Default has not occurred.

~~**“Operational Limitations”** of the Facility are the parameters set forth in Exhibit A describing the physical limitations of the Facility, including the time required for start-up and the limitation on the number of scheduled start-ups per Contract Year.~~

“Operating Period Security” shall have the meaning set forth in Section 6.1(b) hereof.

“Other Facility” shall mean the offshore wind electric generation facility to be located on the Outer Continental Shelf in Bureau of Ocean Energy Management Lease OCS-A 0501 area which is to be owned by Seller.

“Other Facility Agreement” shall mean the Offshore Wind Generation Unit Power Purchase Agreement dated as of the date hereof between Buyer and Seller with respect to the Other Facility, as the same may be amended from time to time.

“Party” and **“Parties”** shall have the meaning set forth in the first paragraph of this Agreement.

“Permit Failure” shall mean the failure of a Party to obtain and maintain, or cause to be obtained and maintained, in full force and effect any Permit (other than the Regulatory Approval) necessary for such Party to perform its obligations under this Agreement without giving effect to any cure period hereunder.

“Permits” shall mean any permit, authorization, license, order, consent, waiver, exception, exemption, variance or other approval by or from, and any filing, report, certification, declaration, notice or submission to or with, any Governmental Entity required to authorize action, including any of the foregoing relating to the ownership, siting, construction, operation, use or maintenance of the Facility under any applicable Law and the Delivery of the Products in accordance with this Agreement.

“Person” shall mean an individual, partnership, corporation, limited liability company, limited liability partnership, limited partnership, association, trust, unincorporated organization, or a ~~government authority~~ Governmental Entity or agency or political subdivision thereof.

“Pool Transmission Facilities” ~~has~~ shall have the meaning given that term in the ISO-NE Rules.

“Power Cost Reconciliation Tariff” shall mean a fully reconciling cost recovery tariff mechanism that authorizes the establishment of a distribution charge that fully recovers Buyer’s net costs under this Agreement (including annual remuneration of up to two and three-quarters percent (2.75%)). The rate reconciliation shall be designed in such a way as to limit the ~~build up~~ buildup of any under or over-recoveries over the course of the year. A reconciliation shall occur at least annually, but may also be reconciled quarterly or monthly, to the extent necessary to eliminate regulatory lag for the recovery of costs or crediting of over-recoveries to customers.

“Price” shall mean the purchase price(s) for Products referenced in Section 5.1 hereof and set forth on Exhibit D.

“Products” shall mean ~~[RECs] [Energy] [Energy and RECs];~~ provided, however, that ~~[RECs] [Energy] [(a) Energy and RECs]~~ generated by or associated with the Facility during the Test Period or in excess of the Contract Maximum Amount ~~and RECs not purchased by Buyer under Section 4.1(b), (b) RECs not purchased by Buyer under Section 4.1(b), (c) Energy and RECs produced by portions of the Facility that are completed during the Additional Construction Period and generated prior to the delivery of the Additional Construction IE Certificate, and (d) any capacity rights associated with the Facility or sold in the FCM,~~ shall not be deemed Products.

“Purchased Power Accounting Authorization” shall mean authorization for Buyer, at Buyer’s sole discretion, to take appropriate steps to assure avoidance of a material, negative balance sheet impact on Buyer or Buyer’s direct or indirect parent company, upon appropriate filing with and approval by the MDPU; provided that such Purchased Power Accounting Authorization shall not impact Buyer’s obligation to purchase the Products under this Agreement or the Price Buyer pays for such Products.

~~**“QF”** shall mean a cogeneration or small power production facility which meets the criteria as defined by FERC in Title 18, Code of Federal Regulations, §§ 292.201 through 292.207, as amended from time to time.~~

“Qualified Bank” shall mean a U.S. commercial bank or the U.S. branch office of a foreign bank, in either case, having (x) assets on its most recent audited balance sheet of at least \$10,000,000,000 and (y) a rating for its senior long-term unsecured debt obligations of at least (A) “A-” by S&P and “A3” by Moody’s, if such entity is rated by both S&P and Moody’s or (B) “A-” by S&P or “A3” by Moody’s, if such entity is rated by either S&P or Moody’s but not both.

“Real-Time Energy Market” shall have the meaning as set forth in the ISO-NE Rules.

“Regulatory Approval” shall mean the MDPU approval of this entire Agreement (including any amendment of this Agreement as provided for herein), which approval shall include without limitation: (1) confirmation that this Agreement has been approved under Section 83C and the regulations promulgated thereunder and that all of the terms of

such Section 83C and such regulations apply to this Agreement; (2) definitive regulatory authorization for Buyer to recover all of its costs incurred under and in connection with this Agreement for the entire term of this Agreement through the implementation of a Power Cost Reconciliation Tariff and/or other cost recovery or reconciliation mechanisms; (3) definitive regulatory authorization for Buyer to recover remuneration of up to two and three-quarters percent (2.75%) of Buyer’s annual payments under this Agreement for the term of this Agreement through the Power Cost Reconciliation Tariff; and (4) approval of any Purchased Power Accounting Authorization requested by Buyer in connection with the Regulatory Approval. Such approvals shall be acceptable in form and substance to Buyer in its sole discretion, shall not include any conditions or modifications that Buyer deems, in its sole discretion, to be unacceptable and shall be final and not subject to appeal or rehearing.

“**Rejected Purchase**” shall have the meaning set forth in Section 4.4 hereof.

~~“**Related Transmission Facilities**” shall mean those transmission and distribution facilities to be used by Seller for Delivery of Energy under this Agreement, as described in Exhibit E hereto.~~

~~“**Related Transmission Approvals**” shall mean those FERC filings, agreements, tariffs and approvals associated with service on the Related Transmission Facilities.~~

“**Reliability Curtailment**” shall mean any curtailment of Delivery of Energy resulting from (i) an emergency condition as defined in the Interconnection Agreement or the ISO-NE Tariff; or (ii) any other order or directive of the Interconnecting Utility or the Transmission Provider relating to reliability pursuant to an Interconnection Agreement or tariff.

“**Remaining Term**” shall have the meaning set forth in Section 9.3(b)(iii) hereof.

“**Renewable Energy Certificates**” or “**RECs**” shall mean all of the Certificates and any and all other Environmental Attributes associated with the Energy or otherwise produced by the Facility which satisfy the RPS for a RPS Class I Renewable Generation Unit, and shall represent title to and claim over all Environmental Attributes associated with the specified MWh of generation from such RPS Class I Renewable Generation Unit.

“**Replacement Energy**” shall mean energy purchased by Buyer as replacement for any Delivery Failure relating to the Energy to be provided hereunder.

“**Replacement Price**” shall mean (A) the price at which Buyer, acting in a commercially reasonable manner, purchases Replacement Energy and Replacement RECs during the Services Term; provided, however, that in no event shall Buyer be required to utilize or change its utilization of its owned or controlled assets, contracts or market positions to minimize Seller’s liability, or (B) if the Buyer elects in its sole discretion not to purchase Replacement Energy and/or Replacement RECs, the market value of energy and the Alternative Compliance Payment Rate as of the date and the time of the Delivery Failure. ~~Definition to be adjusted to reflect Products being sold.~~

- Formatted: Font: Bold
- Formatted: Font: Bold
- Formatted: Font color: Black
- Formatted: Font color: Black
- Formatted: Font: Bold, Italic
- Formatted: Font: Bold
- Formatted: Font color: Black
- Formatted: Font color: Black
- Formatted: Font: Not Bold, Not Italic

“**Replacement RECs**” shall mean any generation or environmental attributes, including any Certificates or other certificates or credits related thereto reflecting generation by a RPS Class I Renewable Generation Unit that are purchased by Buyer as replacement for any RECs not Delivered as required hereunder ~~during the Services Term~~.

“**Resale Damages**” shall mean, with respect to any Rejected Purchase, an amount equal to (a) the positive net amount, if any, by which the applicable Price that would have been paid pursuant to Section 5.1 hereof for such Rejected Purchase, had it been accepted, exceeds the Resale Price multiplied by the quantity of that Rejected Purchase (in MWh and/or RECs, as applicable), plus (b) any applicable penalties assessed by ISO-NE or any other Person against Seller as a result of Buyer’s failure to accept such Products in accordance with the terms of this Agreement, ~~plus (c) transaction and other out-of-pocket costs reasonably incurred by Seller in re-selling such Rejected Purchase that Seller would not have incurred but for the Rejected Purchase.~~ Seller shall provide a written statement for the applicable period explaining in reasonable detail the calculation of any Resale Damages.

“**Resale Price**” shall mean the price at which Seller, acting in a commercially reasonable manner, sells or is paid for a Rejected Purchase, ~~plus transaction and other administrative costs reasonably incurred by Seller in re-selling such Rejected Purchase that Seller would not have incurred but for the Rejected Purchase; provided, however, that, provided, however, that (a) in no event shall Seller be required to utilize or change its utilization of the Facility or its other assets, contracts or market positions in order to minimize Buyer’s liability for such Rejected Purchase, and (b) in the event that Seller is unable to sell any Rejected Purchase, the LMP at the time of such Rejected Purchase will be used to calculate the Resale Price for such Rejected Purchase.~~

“**RPS**” shall mean the requirements established pursuant to Mass. Gen. Laws ch.25A, Section 11F and the regulations promulgated thereunder that require all retail electricity suppliers in Massachusetts to provide a minimum percentage of electricity from RPS Class I Renewable Generation Units, and such successor laws and regulations as may be in effect from time to time.

“**RPS Class I Renewable Generation Unit**” shall mean a Generation Unit termed a New Renewable Generation Unit in a Statement of Qualification issued by the DOER pursuant to 225 CMR 14.00.

“**RTO**” shall mean ISO-NE and any successor organization or entity to ISO-NE, as authorized by FERC to exercise the functions pursuant to FERC’s Order No. 2000 and FERC’s corresponding regulations, or any successor organization, or any other entity authorized to exercise comparable functions in subsequent orders or regulations of FERC.

“**S&P**” shall mean Standard & Poor’s Financial Services LLC, and any successor thereto.

“**Schedule**” or “**Scheduling**” shall mean the actions of Seller and/or its designated representatives pursuant to Section 4.2, of notifying, requesting and confirming to ISO-

NE the quantity of Energy to be delivered on any given day or days (or in any given hour or hours) during the Services Term at the Delivery Point.

“Second Transmission Cable” shall have the meaning set forth in Section 3.4(h) hereof.

~~“Services Term” shall have the meaning set forth in Section 2.2(b) hereof.~~

“**Seller’s Taxes**” shall have the meaning set forth in Section 5.4(a) hereof.

“Services Term” shall have the meaning set forth in Section 2.2(b) hereof.

“**Statement of Qualification**” shall mean a written document from the DOER that qualifies a Generation Unit as an RPS Class I Renewable Generation Unit, or that qualifies a portion of the annual electrical energy output of a Generation Unit as RPS Class I Renewable Generation (as defined in 225 CMR 14.01).

~~“Tax Equity Transaction” shall mean, with respect to Seller, any transaction or series of transactions pursuant to which (i) a Person either (A) obtains less than one hundred percent (100%) of the equity interests in Seller or any entity that has an interest in Seller in connection with a partnership flip transaction or (B) obtains all of the equity interests in Seller in connection with a sale leaseback transaction (in either case, such Person, a “Tax Equity Investor”), (ii) an Indirect Parent Entity, directly or through one or more of its Affiliates retains Control of Seller, subject to the Tax Equity Investor’s right to vote in any major decision with respect to Seller, as provided in the transaction documents, and (iii) Seller retains control of the Facility.~~

“**Term**” shall have the meaning set forth in Section 2.2(a) hereof.

“**Termination Payment**” shall have the meaning set forth in Section 9.3(b) hereof.

~~“Test Energy” shall have the meaning set forth in Section 4.8 hereof.~~

“**Test Period**” shall have the meaning set forth in Section 3.4(a) hereof.

~~“Transfer” shall mean, with respect to any Posted Collateral or Interest Amount, and in accordance with the instructions of the Party entitled thereto:~~

~~(a) — in the case of Cash, payment or transfer by wire transfer into one or more bank accounts specified by the Party to whom such Cash is being delivered; and~~

~~(b) — in the case of Letters of Credit, delivery of the Letter of Credit or an amendment thereto to the Party to whom such Letter of Credit is being delivered.~~

“Third Party Delivery” shall have the meaning set forth in Section 4.1(c) hereof.

“**Transmission Provider**” shall mean (a) ISO-NE, its respective successor or Affiliates; (b) Buyer, ~~solely in its role as a Person that provides transmission services to Seller;~~ and/or (c) such other third parties from whom transmission services are necessary for Seller to fulfill its performance obligations to Buyer hereunder, as the context requires.

“**Transmission System**” shall mean the transmission facilities operated by a Transmission Provider, now or hereafter in existence, which provide energy transmission service for the Energy to or from the Delivery Point.

“**Unit Contingent**” shall mean that the Products are to be supplied only from the Facility and only to the extent that the Facility is generating Energy.

2. EFFECTIVE DATE; TERM

2.1 Effective Date. Subject in all respects to Article 8, this Agreement is effective as of the Effective Date.

2.2 Term.

(a) The “**Term**” of this Agreement is the period beginning on the Effective Date and ending upon the ~~final settlement of all obligations hereunder after the~~ expiration of the Services Term or the earlier termination of this Agreement in accordance with its terms.

(b) The “**Services Term**” is the period during which Buyer is obligated to purchase Products Delivered to Buyer by Seller ~~(not including Energy and RECs Delivered during the Test Period under Section 4.8)~~ commencing on the Commercial Operation Date and continuing for a period of ~~{15 to 20}~~ years from the Commercial Operation Date, unless this Agreement is earlier terminated in accordance with the provisions hereof.

(c) At the expiration of the Term or earlier termination of this Agreement pursuant to the terms hereof, the Parties shall no longer be bound by the terms and provisions hereof, except (i) to the extent necessary to make payments of any amounts owed to the other Party arising prior to or resulting from termination of, or on account of a breach of, this Agreement, (ii) to the extent necessary to enforce the rights and the obligations of the Parties arising under this Agreement before such expiration or termination, ~~and (iii) the limitations on damages set forth in Section 9.3(e), and (iv)~~ the obligations of the Parties hereunder with respect to confidentiality and indemnification shall survive the expiration or termination of this Agreement for the periods set forth in Sections 12.1 and 13.5, respectively; provided, however, that the Parties agree that Seller’s obligation to replenish any Credit Support as required by Section 6.1(a) shall not survive the expiration of the Term or the earlier termination of this Agreement pursuant to the terms hereof.

3. FACILITY DEVELOPMENT AND OPERATION

3.1 Critical Milestones.

(a) Subject to the provisions of ~~Section~~Sections 3.1(c), 3.1(d), 3.1(e) and 10.1 commencing on the Effective Date, Seller shall develop the Facility in order to achieve the following milestones ("**Critical Milestones**") on or before the dates set forth in this Section 3.1(a):

- (i) receipt of all Permits necessary to construct the Facility, as set forth in Exhibit B, in final form, by [REDACTED]
- (ii) acquisition of all required real property rights in ~~additional~~addition to the federal lease referenced in Section 7.2(m) necessary for construction and operation of the Facility and the interconnection of the Facility to the Interconnecting Utility in full and final form with all options and/or contingencies having been exercised demonstrating complete site control as set forth in Exhibit B, by [REDACTED]
- (iii) closing of the Financing or other demonstration to Buyer's satisfaction of the financial capability to construct the Facility, including, as applicable, Seller's financial obligations with respect to interconnection of the Facility to the Interconnecting Utility and construction of the Network Upgrades by [REDACTED] and [REDACTED]
- (iv) achievement of the Commercial Operation Date by ~~{~~January 15, 2022 ("Guaranteed Commercial Operation Date")~~}~~. ~~[This date shall not be earlier than January 1, 2018 and not later than December 31, 20[]-].~~

(b) Seller shall provide Buyer with written notice of the achievement of each Critical Milestone within seven (7) days after that achievement, which notice shall include information demonstrating with reasonable specificity that such Critical Milestone has been achieved. Seller acknowledges that Buyer will receive such notice solely to monitor progress toward the Commercial Operation Date, and Buyer shall have no responsibility or liability for the development, construction, operation or maintenance of the Facility.

(c) Seller may elect to extend all of the dates for the Critical Milestones not yet achieved by up to four six-month periods from the applicable dates set forth in Section 3.1(a) by posting additional Development Period Security in an amount equal to \$1,057,000 (which is equal to \$5,000 -per MWh per hour of the Contract Maximum Amount) for each such six-month period. Any such election shall be made in a written notice delivered to Buyer on or prior to the first date for a Critical Milestone that has not yet been achieved (as such date may have previously been extended).

(d) To the extent a Force Majeure event pursuant to Section 10.1 has occurred ~~that, and such event~~ prevents the Seller from achieving the Critical Milestone date for acquisition of real property rights and interconnection (Section 3.1(a)(ii)) or the Commercial Operation Date (Section 3.1(a)(iv)) by the applicable Critical Milestone date, the Critical Milestone Date(s) impacted by such Force Majeure event shall be extended for the duration of the Force Majeure event, but under no circumstances shall extensions of those Critical Milestone ~~dates~~Dates due to Force Majeure events exceed ~~twelve (12)~~twenty-four (24) months beyond the applicable Critical Milestone date, and further provided, that the Seller shall not have the right to declare a Force Majeure event related to the Permits Critical Milestone (Section 3.1(a)(i)) or the Financing Critical Milestone (Section 3.1(a)(iii)).

(e) In the event that the MDPU Order is appealed, the dates for each of the Critical Milestones that has not been achieved prior to that appeal being filed shall be extended on a day-for-day basis for the period of time from such appeal being filed until such appeal is finally determined; provided, however, that this Section 3.1(e) will not affect the rights of the Parties to terminate this Agreement under Section 8.1.

(f) Notwithstanding the other provisions of this Agreement, or the rights of Seller pursuant to Sections 3.1(c), 3.1(d), 3.1(e) and 10.1, in no event shall the Guaranteed Commercial Operation Date be extended beyond [REDACTED]

(g) The Parties agree that time is of the essence with respect to the Critical Milestones and is part of the consideration to Buyer in entering into this Agreement.

3.2 Delay Damages.

(a) If the Commercial Operation Date is not achieved by the Guaranteed Commercial Operation Date ~~(as extended pursuant to Sections 3.1(e) and 10.1)~~, Seller shall pay to Buyer damages for each day from and after ~~such date~~the Guaranteed Commercial Operation Date in an amount of \$21,140 (which is equal to \$100.00 per MWh per hour of the Contract Maximum Amount), commencing on the Guaranteed Commercial Operation Date (as extended pursuant to Sections 3.1(c), 3.1(d), 3.1(e) and 10.1) and ending on the earlier of (i) the Commercial Operation Date, (ii) the date that Buyer exercises its right to terminate this Agreement under Section 9.3, or (iii) the date that is twelve (12) months after the Guaranteed Commercial Operation Date (“**Delay Damages**”). Delay Damages shall be due under this Section 3.2(a) without regard to whether Buyer exercises its right to terminate this Agreement pursuant to Section 9.3; provided, however, that if Buyer exercises its right to terminate this Agreement under Section 9.3, Delay Damages shall be due and owing to the extent that such Delay Damages were due and owing at the date of such termination. Notwithstanding the foregoing, the Parties agree that if the Commercial Operation Date is not achieved by the Guaranteed Commercial Operation Date and, at least thirty (30) days prior to the Guaranteed Commercial Operation Date, Seller (x) provides certification acceptable to Buyer, from an Independent Engineer with supporting detail and information that demonstrates that the Commercial Operation Date is reasonably likely to occur on or prior to the one year anniversary of the Guaranteed Commercial Operation Date (as such date may be extended), (y) has exercised its rights to extend all of the Critical Milestone Dates pursuant to Section 3.1(c) the maximum number of times allowed pursuant to the terms of this Agreement, and (z) posts additional Credit

Support in an amount equal to \$7,716,100 (which is equal to twelve (12) months of Delay Damages), then Buyer shall not exercise its rights to terminate this Agreement due to an Event of Default under Section 9.2(e) until the date that is twelve (12) months after the Guaranteed Commercial Operation Date as long as Seller is paying Delay Damages in accordance with the provision of this Section 3.2.

(b) Each Party agrees and acknowledges that (i) the damages that Buyer would incur due to Seller's delay in achieving the Commercial Operation Date by the Guaranteed Commercial Operation Date would be difficult or impossible to predict with certainty, and (ii) it is impractical and difficult to assess actual damages in the circumstances stated, and therefore the Delay Damages as agreed to by the Parties and set forth herein are a fair and reasonable calculation of such damages. Notwithstanding the foregoing, this Article shall not limit the amount of damages payable to Buyer if this Agreement is terminated as a result of Seller's failure to achieve the Commercial Operation Date. Any such termination damages shall be determined in accordance with Article 9.

(c) By the ~~tenth (10th)~~fifteenth (15th) day following the end of the calendar month in which Delay Damages first become due and continuing by the ~~tenth (10th)~~fifteenth (15th) day of each calendar month during the period in which Delay Damages accrue (and the following months if applicable), Buyer shall deliver to Seller an invoice showing Buyer's computation of such damages and any amount due Buyer in respect thereof for the preceding calendar month. No later than ten (10) days after receiving such an invoice, Seller shall pay to Buyer, by wire transfer of immediately available funds to an account specified in writing by Buyer or by any other means agreed to by the Parties in writing from time to time, the amount set forth as due in such invoice. If Seller fails to pay such amounts when due, Buyer may draw upon the Development Period Security for payment of such Delay Damages, and Buyer may exercise any other remedies available for Seller's default hereunder.

3.3 Construction and Changes in Capacity.

(a) Construction of Facility. Seller shall construct the Facility as described in Exhibit A, in accordance with Good Utility Practice, the manufacturer's guidelines for all material components of the Facility and all requirements of the ISO-NE Rules and ISO-NE Practices for the delivery of the Products to Buyer. Seller shall bear all costs related thereto. Seller may contract with other Persons to provide construction functions, so long as Seller ~~maintains~~shall at all times maintain overall direction and control over the construction of the Facility ~~through the Term~~.

(b) ~~Capacity Deficiency~~Reduced Facility Size. To the extent that Seller has constructed the Facility in accordance with Good Utility Practice, and met all other requirements for the ~~Commercial Operation Date under Section 3.4(b) of this Agreement,~~ but there is a Capacity Deficiency ~~exists~~ on the Commercial Operation Date ~~as permitted by Section 3.4(b),~~ then on at least thirty (30) days prior to the anticipated Commercial Operation Date, Seller shall provide written notice to Buyer as to whether it is electing to exercise the Capacity Downsize Option and/or to continue with the Additional Construction Period, each as described in Section 3.4. Upon the written notice from the Seller of an election to exercise the Capacity Downsize Option or upon delivery of the Additional Construction IE Certificate with an Actual Facility

Size that is less than the Expected Nameplate Capacity (as adjusted to reflect any previous election of the Capacity Downsize Option), as applicable, and the payment of Capacity Deficiency Damages under Section 3.4(g), the Contract Maximum Amount shall be automatically and permanently reduced commensurate with the ~~Capacity Deficiency~~Actual Facility Size, which reduced Contract Maximum Amount shall be stated in a notice from Buyer to Seller, which notice shall be binding absent manifest error.

(c) Increase in Facility Size. To the extent that Seller has constructed the Facility in accordance with Good Utility Practice, and met all other requirements under Section 3.4(b) of this Agreement, if the Independent Engineer’s certification provides that the Actual Facility Size exceeds the ~~Proposed Facility Size~~Expected Nameplate Capacity as provided in Exhibit A, the Buyer’s Percentage Entitlement will be recalculated and replaced by the percentage derived by dividing the Contract Maximum Amount by the Actual Facility Size.

(d) Progress Reports. Within ten (10) days of the end of each calendar quarter after the Effective Date and until the Commercial Operation Date, Seller shall provide Buyer with a progress report regarding Critical Milestones not yet achieved, including projected time to completion of the Facility, in accordance with the form attached hereto as Exhibit C, and shall provide supporting documents and detail regarding the same upon Buyer’s request. Seller shall permit Buyer and its advisors and consultants to review and discuss with Seller and its advisors and consultants such progress reports during business hours and upon reasonable notice to Seller.

(e) Site Access. Subject to the requirements of Section 4.6(d) with respect to the inspection of Meters, Buyer and its representatives shall have the right but not the obligation, during business hours and upon reasonable notice to Seller, to inspect the Facility site and view the construction of the Facility, subject to Seller’s and its contractors’ reasonable site access rules and any requirements of Buyer’s insurance providers.

(f) Exhibit Updates. Upon Seller giving the notice to proceed with the construction of the Facility and again within thirty (30) days after the Commercial Operation Date, or the delivery of the Additional Construction IE Certificate, as applicable, Seller shall provide Buyer with updated versions of Exhibit A to reflect the as-built Facility, including the Actual Facility Size.

3.4 Commercial Operation.

(a) Seller’s obligation to Deliver the Products and Buyer’s obligation to pay Seller for such Products commences on the Commercial Operation Date; provided, that Energy and RECs generated by the Facility prior to the Commercial Operation Date (the “**Test Period**”) shall not be deemed Products.

(b) The Commercial Operation Date shall occur on the date on which the Facility as described in Exhibit A is completed (subject, if applicable, to a Capacity Deficiency so long as the Actual Facility Size on the Commercial Operation Date ~~is~~ (1) is at least ~~_____~~ of the ~~proposed nameplate capacity of the Facility as set forth in Exhibit A~~Expected Nameplate Capacity, and (2) has not been decreased by more than ~~_____~~ MW less than the proposed nameplate capacity of the Facility set forth

~~in Exhibit A from the Expected Nameplate Capacity~~) and capable of regular commercial operation in accordance with Good Utility Practice, the manufacturer’s guidelines for all material components of the Facility, all requirements of the ISO-NE Rules and ISO-NE Practices for the delivery of the Products to the Buyer have been satisfied, ~~and all performance testing for the Facility has been successfully completed~~, provided Seller has also satisfied the following conditions precedent as of such date~~;~~:

- (i) ~~completion~~Completion and commissioning of all transmission and interconnection facilities and any COD Network Upgrades, including final acceptance and authorization to interconnect the ~~Facility~~ from ISO-NE or the Interconnecting Utility in accordance with the fully executed Interconnection Agreement and as required to interconnect the Facility at a level that (A) is capable of satisfying the ~~Interconnection Point at the~~ Capacity Capability Interconnection Standard at the Interconnection Point under the ISO-NE Rules; ~~_____~~
~~_____~~
~~_____~~
~~_____~~

- ~~(ii) — all Related Transmission Facilities as set forth in Exhibit E are complete and in service;~~

~~(ii)~~(ii) Seller has obtained and demonstrated possession of all Permits required for the lawful construction and operation of the Facility, for the interconnection of the Facility to the Interconnecting Utility (including any COD Network Upgrades) and for Seller to perform its obligations under this Agreement, including but not limited to Permits related to environmental matters, all as set forth on Exhibit B;

~~(iii)~~(iii) Seller has obtained qualification by the DOER qualifying the Facility as a RPS Class I Renewable Generation Unit;

- ~~(v) — all Related Transmission Approvals have been received;~~

~~(iv)~~(iv) Seller has acquired all real property rights needed to construct and operate the Facility, to interconnect the Facility to the Interconnecting Utility, to construct the COD Network Upgrades (to the extent that it is Seller’s responsibility to do so) and to perform Seller’s obligations under this Agreement;

~~(vii)~~(v) Seller (or the party with whom Seller contracts pursuant to Section 3.5(e)) has established all ISO-NE-related accounts and entered into all ISO-NE-related agreements required for the performance of Seller’s obligations in connection with the Facility and this

Agreement, which agreements shall be in full force and effect, including the registration of the Facility in the GIS;

~~(viii)~~(vi) Seller has provided to Buyer I.3.9 Confirmation from ISO-NE regarding approval of generation entry, has submitted the Asset Registration Form (as defined in ISO-NE Practices) for the Facility to ISO-NE and has taken such other actions as are necessary to effect the Delivery of the Energy to Buyer in the ISO Settlement Market System;

~~(ix)~~(vii) Seller has successfully completed all pre-operational testing and commissioning in accordance with manufacturer guidelines required for reliable operation of the Facility;

~~(x)~~(viii) Seller has satisfied all Critical Milestones that precede the Commercial Operation Date in Section 3.1;

~~(xi)~~(ix) no ~~default~~Default or Event of Default by Seller shall have occurred and remain uncured;

~~(xii)~~(x) the Facility is owned or leased by, and under the care, custody and control of, Seller.

~~(xiii)~~(xi) Seller has delivered to Buyer:

- (A) an Independent Engineer’s certification stating (i) that the Facility has been completed in all material respects (excepting ~~punchlist~~ items that do not materially and adversely affect the ability of the Facility to operate as intended hereunder and) in accordance with this Agreement, and (ii) the Actual Facility Size as of such date;
- (B) certificates of insurance evidencing the coverages required under Section 3.5(i); and

~~(xiv)~~(xii) Seller has demonstrated that it can reliably transmit real time data and measurements to ISO-NE.

(c) If the Facility achieves the Commercial Operation Date with a Capacity Deficiency, Seller may make a one-time election (the “Capacity Downsize Option”) at least thirty (30) days prior to the anticipated Commercial Operation Date to decrease the size of the Facility as described in Exhibit A by up to [REDACTED]. Upon exercise of the Capacity Downsize Option for only a portion of the remaining Expected Nameplate Capacity, and upon the payment of any required Capacity Deficiency Damages under Section 3.4(g), the Expected Nameplate Capacity will be revised to reflect Seller’s election of the Capacity Downsize Option in all respects.

(d) If the Facility achieves the Commercial Operation Date with a Capacity Deficiency, and Seller has not exercised the Capacity Downsize Option, or has exercised the Capacity Downsize Option for only a portion of the remaining Expected Nameplate Capacity, then Seller will use commercially reasonable efforts to construct and install the remaining Expected Nameplate Capacity (as adjusted in accordance with Section 3.4(c)) into the Facility

Notwithstanding the foregoing, (i) the Services Term will commence on the Commercial Operation Date, and each escalation of the Price under Exhibit D will occur on the anniversary of the Commercial Operation Date, and (ii) the same Services Term shall apply to the capacity installed as of the Commercial Operation Date and any remaining Capacity installed during the Additional Construction Period, and that Services Term shall not be extended on account of any remaining capacity installed after the Commercial Operation Date.

(e) On the earlier of (i) the date that Seller has completed the construction and installation of the remaining Expected Nameplate Capacity and incorporated it into the Facility, and (ii) the last day of the Additional Construction Period, Seller shall delivery to Buyer an Independent Engineer's certification (the "Additional Construction IE Certificate") stating (A) that the portions of the Facility constructed during the Additional Construction Period have satisfied all applicable criteria for the Commercial Operation Date with respect to such additional portions of the Facility, and (B) the Actual Facility Size as of such date. No Energy or RECs (i) attributable to the portion of the Facility completed during the Additional Construction Period and (ii) generated prior to the delivery of the Additional Construction IE Certificate to Buyer, shall be purchased or sold under this Agreement.

(f) During the Additional Construction Period that is after the Guaranteed Commercial Operation Date, the Seller will pay Delay Damages, which Delay Damages shall be pro-rated to reflect the remaining Expected Nameplate Capacity, until the earlier of (i) the date Seller delivers the Additional Construction IE Certificate to Buyer, and (ii) the last day of the Additional Construction Period. Each Party agrees and acknowledges that (1) the damages that Buyer would incur due to Seller's delay in achieving the Commercial Operation Date with the entire Expected Nameplate Capacity of the Facility by the Guaranteed Commercial Operation Date would be difficult or impossible to predict with certainty, and (2) it is impractical and difficult to assess actual damages in the circumstances stated, and therefore the Delay Damages as agreed to by the Parties and set forth herein are a fair and reasonable calculation of such damages.

(g) If, upon either (i) the Commercial Operation Date if Seller has exercised the Capacity Downsize Option with respect to all of the Expected Nameplate Capacity that has not been incorporated into the Facility on the Commercial Operation Date, or, (ii) if Seller has not exercised the Capacity Downsize Option with respect to all of the Expected Nameplate Capacity that has not been incorporated into the Facility on the Commercial Operation Date, the later of (1) the date of the delivery of the Additional Construction IE Certificate or (2) the expiration of the Additional Construction Period, the Actual Facility Size is less than [REDACTED] MW, then Seller will pay to Buyer damages for the remaining Capacity Deficiency on such date equal to [REDACTED] per MW by which the Actual Facility Size is less than [REDACTED] MW ("Capacity Deficiency Damages"). Each Party agrees and acknowledges that (i) the damages that Buyer

would incur due to Seller’s failure to achieve the entire Expected Nameplate Capacity of the Facility of [REDACTED] MW would be difficult or impossible to predict with certainty, and (ii) it is impractical and difficult to assess actual damages in the circumstances stated, and therefore the Capacity Deficiency Damages as agreed to by the Parties and set forth herein are a fair and reasonable calculation of such damages.

(h) Notwithstanding Section 3.4(b)(i) above, if on the date that the Facility has otherwise satisfied all conditions to the Commercial Operation Date, (i) Seller has not commissioned the second subsea transmission cable that connects the offshore electrical service platform that serves the Facility and the Other Facility to the Interconnection Point (the “**Second Transmission Cable**”) as required by Section 3.4(b)(i), (ii) Seller has demonstrated to Buyer’s satisfaction that Seller has procured all materials and contracted for all services necessary for the completion and commissioning of the Second Transmission Cable, (iii) the failure to commission the Second Transmission Cable by such date is due solely to Force Majeure, and (iv) notwithstanding the failure to commission the Second Transmission Cable, the completed and commissioned transmission and interconnection facilities for the Facility are adequate to permit the Delivery of all Energy produced by the Facility completed at the full Expected Nameplate Capacity, then Seller may, at its option, elect to have the Commercial Operation Date deemed to occur on that date, and the Services Term will commence on that date. If Seller elects to have the Commercial Operation Date deemed to have occurred on such date, Seller shall complete and commission the Second Transmission Cable by [REDACTED]

[REDACTED]. In the event that Seller fails to complete and commission the Second Transmission Cable by [REDACTED]

[REDACTED] Each Party agrees and acknowledges that (i) the damages that Buyer would incur due to Seller’s failure to complete and commission the Second Transmission Cable by [REDACTED] would be difficult or impossible to predict with certainty, and (ii) it is impractical and difficult to assess actual damages in the circumstances stated, and therefore the liquidated damages as agreed to by the Parties and set forth herein are a fair and reasonable calculation of such damages.

3.5 Operation of the Facility.

(a) Compliance With Utility Requirements. Seller shall comply with, and shall cause the Facility to comply with: (i) Good Utility Practice; ~~(ii) the Operational Limitations; and (iii)~~ (ii) all applicable rules, procedures, operating policies, criteria, guidelines and requirements imposed by ISO-NE, any Transmission Provider, any Interconnecting Utility, NERC and/or any regional reliability entity, including, in each case, all practices, requirements, rules, procedures and standards related to Seller’s construction, ownership, operation and maintenance of the Facility and its performance of its obligations under this Agreement (including obligations related to the generation, Scheduling, interconnection, and transmission of Energy, and the transfer of RECs), whether such requirements were imposed prior to or after the Effective Date. Seller shall be solely responsible for registering as the “Generator Owner and Generator Operator” of the Facility with NERC and any applicable regional reliability entities, as applicable.

(b) Permits. Seller shall maintain or cause to be maintained in full force and effect all Permits necessary for it to perform its obligations under this Agreement, including all Permits necessary to construct, operate and maintain the Facility ~~and all Related Transmission Approvals~~.

(c) Maintenance and Operation of Facility. Seller shall, at all times during the Term, construct, maintain and operate the Facility in accordance with Good Utility Practice and in accordance with Exhibit A to this Agreement. Seller shall bear all costs related thereto. Seller may contract with other Persons to provide construction, operation and maintenance functions, so long as Seller ~~maintains overall control over the construction, operation and maintenance of the Facility throughout the Term~~ shall at all times maintain overall direction and control over the construction, operation and maintenance of the Facility throughout the Term. No later than (a) the Commercial Operation Date and (b) two months prior to the end of each calendar year thereafter during the Term, Seller shall submit to Buyer a schedule of planned maintenance for the following calendar year for the Facility. Throughout the Services Term, Seller shall coordinate all planned maintenance with ISO-NE, consistent with ISO-NE Rules, and shall promptly provide applicable information concerning scheduled outages, as determined by ISO-NE, to Buyer. To maximize the value of the Products, to the extent possible and consistent with ISO-NE Rules, Seller shall (i) not schedule maintenance of the Facility during the months of December, January and February, (ii) not schedule maintenance requiring more than twenty-five percent (25%) of the Facility to be offline at any single time during the months of July and August and (iii) not schedule maintenance requiring more than fifty percent (50%) of the Facility to be offline at any single time during the months of June and September; provided, however, that planned maintenance may be scheduled during such period to the extent the failure to perform such planned maintenance is contrary to operation of the Facility in accordance with Good Utility Practice or equipment manufacturer requirements. Seller shall take commercially reasonable steps to operate the Facility so as to minimize any unplanned outages during the hours of anticipated peak load and Energy prices in New England.

(d) Interconnection Agreement. Seller shall comply with the terms and conditions of the Interconnection Agreement and shall be responsible for obtaining interconnection of the Facility at the Interconnection Point at a level that is capable of satisfying the Capacity Capability Interconnection Standard under the ISO-NE Rules.

(e) ISO-NE Status. Seller shall, at all times during the Services Term, either: (i) be an ISO-NE "Market Participant" pursuant to the ISO-NE Rules; or (ii) have entered into an agreement with a Market Participant that shall perform all of Seller's ISO-NE-related obligations in connection with the Facility and this Agreement.

(f) Forecasts. Commencing at least thirty (30) days prior to the anticipated Commercial Operation Date and continuing throughout the Term, Seller shall update and deliver to Buyer on an annual basis and in a form reasonably acceptable to Buyer, twelve (12) month rolling forecasts of Energy production by the Facility, ~~which~~. All required forecasts shall be prepared in good faith and in accordance with Good Utility Practice based on historical performance, ~~(other than with respect to the first such forecast)~~, maintenance schedules, Seller's generation projections and other relevant data and considerations; provided, however, the Parties agree that all such forecasts shall be non-binding, good-faith estimates only, and Seller shall not

be in default hereunder for any forecasting errors. Any notable changes from prior forecasts or historical energy delivery shall be noted and an explanation provided. The provisions of this section are in addition to Seller's requirements under ISO-NE Rules and ISO-NE Practices, including ISO-NE Operating Procedure No. 5.

(g) RPS Class I Renewable Generation Unit. Subject to Section 4.7(b), Seller shall be solely responsible at Seller's cost for qualifying the Facility as a RPS Class I Renewable Generation Unit and maintaining such qualification throughout the Services Term. Seller shall take all actions necessary to register for and maintain participation in the GIS to register, monitor, track, and transfer RECs. Seller shall provide such additional information as Buyer may reasonably request relating to such qualification and participation and the registration, monitoring, tracking and transfer of RECs.

(h) Compliance Reporting. Within thirty (30) days following the end of each calendar quarter, Seller shall provide Buyer information pertaining to emissions, fuel types, labor information and any other information to the extent required by Buyer to comply with the disclosure requirements contained under applicable law/Law and any other such disclosure regulations which may be imposed upon Buyer during the Term, which information requirements will be provided to Seller by Buyer at least fifteen (15) days before the beginning of the calendar quarter for which the information is required. To the extent Buyer is subject to any other certification or compliance reporting requirement with respect to the Products produced by Seller and delivered to Buyer hereunder, Seller shall provide any information in its possession (or, if not in Seller's possession, available to it and not reasonably available to Buyer) requested by Buyer to permit Buyer to comply with any such reporting requirement.

(i) Insurance. Throughout the Term, and without limiting any liabilities or any other obligations of Seller hereunder, Seller shall secure and continuously carry with an insurance company or companies rated not lower than "A-" by the A.M. Best Company (or any successor thereto) ~~the insurance coverage and with the deductibles that are customary for a generating facility of the type and size of the Facility and as otherwise legally required. Upon the execution of this Agreement~~ insurance coverage as needed to secure its obligations and potential liabilities under this Agreement to the extent available on commercially reasonable terms and conditions. The insurance coverage will include at least the coverage specified on Exhibit G. Prior to the earlier of (i) Seller giving the notice to proceed with the construction of the Facility or with the construction of the interconnection facilities or (ii) the Financial Closing Date, and at each subsequent policy renewal date thereafter, Seller shall provide Buyer with a certificate of insurance which (i) shall include Buyer as an additional insured on each policy, (ii) shall not include the legend "certificate is not evidence of coverage" or any statement with similar effect, (iii) shall evidence a firm obligation of the insurer to provide Buyer with thirty (30) days prior written notice of coverage modifications that may adversely affect Buyer, and (iv) shall be endorsed by a Person who has authority to bind the insurer. If any coverage is written on a "claims-made" basis, the certification accompanying the policy shall conspicuously state that the policy is "claims made."

(j) Contacts. Each Party shall identify a principal contact or contacts, which contact(s) shall have adequate authority and expertise to make day-to-day decisions with respect to the administration of this Agreement.

(k) Compliance with Law. Without limiting the generality of any other provision of this Agreement, Seller shall be responsible for complying with all applicable requirements of Law, including all applicable rules, procedures, operating policies, criteria, guidelines and requirements imposed by FERC and any other Governmental Entity, whether imposed pursuant to existing Law or procedures or pursuant to changes enacted or implemented during the Term, including all risks of operational and environmental matters relating to the Facility or the Facility site. Seller shall indemnify Buyer, in accordance with the provisions of Article 13, against any and all claims arising out of or related to such environmental matters and against any costs imposed on Buyer as a result of Seller's violation of any applicable Law, or ISO-NE or NERC requirements. For the avoidance of doubt, Seller shall be responsible for procuring, at its expense, all Permits and governmental approvals required for the construction and operation of the Facility in compliance with applicable requirements of Law.

(l) FERC Status. Seller shall be responsible for ensuring that it is in compliance with all FERC directives and requirements necessary for Seller to fulfill its obligations under this Agreement. As part of Seller's satisfaction of this responsibility, it shall maintain the Facility's status as a ~~QF or~~EWG (to the extent Seller meets the criteria for such status) at all times on and after the Commercial Operation Date and shall obtain and maintain any requisite authority to sell the output of the Facility at market-based rates, including market-based rate authority to the extent applicable. ~~If Seller certifies the Facility as a QF, for so long as this Agreement is in effect, Seller waives, and agrees not to assert, any rights Seller may have to require Buyer to purchase or transmit electric power or to pay a specified price for electric power by virtue of the status of the Facility as a QF.~~

~~(m) — Emissions. Seller shall be responsible for all costs associated with the Facility's emissions, including the cost of procuring emission reductions, offsets, allowances or similar items associated with the Facility's emissions, to the extent required to operate the Facility. Without limiting the generality of the foregoing, failure or inability of Seller to procure emission reductions, offsets, allowances or similar items associated with the Facility's emissions shall not constitute a Force Majeure.~~

~~(n) — Maintenance. No later than (a) the Commercial Operation and (b) two months prior to the end of each calendar year thereafter during the Term, Seller shall submit to Buyer a schedule of planned maintenance for the following calendar year for the Facility. Throughout the Term, Seller shall coordinate all planned maintenance with ISO-NE, consistent with ISO-NE Rules, and shall promptly provide applicable information concerning scheduled outages, as determined by ISO-NE, to Buyer. To maximize the value of the Products, to the extent possible and consistent with ISO-NE Rules, Seller shall not schedule maintenance of the Facility during the months of December, January and February or June through September, and shall operate the Facility so as to maximize energy production during the hours of anticipated peak load and Energy prices in New England; provided, however, that planned maintenance may be scheduled during such period to the extent the failure to perform such planned maintenance is contrary to operation of the Facility in accordance with Good Utility Practice.~~

3.6 Interconnection and Delivery Services.

(a) Seller shall be responsible for all costs associated with interconnection of the Facility at the Interconnection Point at a level that is capable of satisfying the Capacity Capability Interconnection Standard under the ISO-NE Rules and with Delivery of the Energy at the Delivery Point, including the costs of the Network Upgrades, consistent with all standards and requirements set forth by the FERC, ISO-NE, any other applicable Governmental Entity and the Interconnecting Utility. Seller shall be responsible for procuring delivery service to the Delivery Point and all costs associated with it.

(b) Seller shall defend, indemnify and hold Buyer harmless, in accordance with the provisions of Article 13, against any and all liabilities, fees, costs and expenses, including but not limited to reasonable attorneys' fees arising due to Seller's performance or failure to perform under the Interconnection Agreement or any agreement for delivery service associated with Seller's performance of its obligations under this Agreement.

3.7 Forward Capacity Market Participation and Network Upgrades.

(a) As of the Effective Date, Seller has applied to participate in the FCM auction qualification process as required [REDACTED] and Seller will continue to pursue that application to the extent required to identify all Network Upgrades that are required to satisfy the interconnection requirements of such Seasonal Claimed Capabilities or, if greater, the maximum summer and winter Seasonal Claimed Capabilities allowed for the Facility and the Other Facility as determined by ISO-NE during the FCM auction qualification process. The Seller agrees to commit to pay for all necessary Network Upgrades identified by ISO-NE required to satisfy the interconnection requirements for participation of the Facility and the Other Facility in the FCM, subject to the terms of this Section 3.7.

(b) Upon determination by ISO-NE of the Network Upgrades required to satisfy the interconnection requirements for participation of the Facility in the FCM as described in Section 3.7(a), the following process shall apply:

- (i) Within fifteen (15) days after determination by ISO-NE of the Network Upgrades required to satisfy the interconnection requirements for FCM participation by the Facility and the Other Facility at the level described in Section 3.7(a), Seller will provide notice to Buyer of: (1) such Network Upgrades identified by ISO-NE; (2) the estimated cost to Seller of such Network Upgrades; (3) whether Seller will pay for such Network Upgrades identified by ISO-NE, and (4) if not, the reduced Seasonal Claimed Capabilities that would be supported by the Network Upgrades that Seller proposes to finance instead.
- (ii) If Seller proposes to finance Network Upgrades that would support Seasonal Claimed Capabilities that are less than those described in

Section 3.7(a), Buyer must notify Seller within thirty (30) days after receipt of Seller’s notification described in clause (i) above as to whether Buyer will accept those reduced Seasonal Claimed Capabilities.

(iii) If Seller proposes to finance Network Upgrades that would support Seasonal Claimed Capabilities that are less than those described in Section 3.7(a), then during the up to 30-day period between Seller’s notice in clause (i) and Buyer’s notice in clause (ii), Buyer and Seller will negotiate in good faith in order to determine whether they can agree to amendments to this Agreement to address Seller’s concern with construction of the Network Upgrades described in Section 3.7(a); provided that neither Party will be obligated to agree to any such amendment or to continue such negotiations for any specific period of time.

(iv) If Buyer notifies Seller that it will not accept the reduced Seasonal Claimed Capabilities proposed by Seller under Section 3.7(b)(i), Buyer may terminate this Agreement upon at least ten (10) Business Days’ written notice to Seller, and, upon such termination, Buyer shall liquidate and retain all Development Period Security provided by Seller as of such date. Upon such termination of this Agreement and retention of the liquidated Development Period Security, neither Party will have any further obligations under this Agreement.

(c) Any Network Upgrades required under this Agreement that are not COD Network Upgrades must be completed by [REDACTED]

(d) Seller will provide Buyer with written notice of the completion of the Network Upgrades required under this Agreement within fifteen (15) days after such completion.

(e) The Parties acknowledge and agree that participation by Seller in the FCM auction qualification process described in Section 3.7(a) is only intended to allow ISO-NE to determine those Network Upgrades that are required to deliver the Seasonal Claimed Capabilities described in Section 3.7(a) and, except as described in this Section 3.7, Seller is not required under this Agreement to participate in the FCM or any other capacity market.

(f) This Section 3.7 is effective upon the Effective Date and without regard to whether the MDPU Order or the Regulatory Approval is issued prior to the events and processes described herein.

4. DELIVERY OF PRODUCTS

4.1 Obligation to Sell and Purchase Products.

(a) Beginning on the Commercial Operation Date and subject to ~~Section~~Sections 4.1(b) and 4.2(a), Seller shall sell and Deliver, and Buyer shall purchase and receive all right, title and interest in and to, Buyer's Percentage Entitlement of the Products in accordance with the terms and conditions of this Agreement, but in no event exceeding the Contract Maximum Amount in such hour, in accordance with the terms and conditions of this Agreement. The aforementioned obligations for Seller to sell and Deliver the Products and for Buyer to purchase and receive the same are Unit Contingent and shall be subject to the operation of the Facility. ~~Seller agrees that Seller will not curtail or otherwise reduce deliveries of the Products in order to sell such Products to other purchasers. To maximize the value of the Products, to the extent possible and consistent with ISO NE Rules and Good Utility Practice, Seller shall use commercially reasonable efforts to maximize the production and Delivery of Energy during the time periods of anticipated peak load and peak Energy prices in New England.~~

(b) Buyer shall not be obligated to accept or pay for any REC or comparable certificate, credit, attribute or other similar product produced by or associated with the Facility which fails to satisfy the RPS as an Environmental Attribute associated with the specified MWh of generation from a RPS Class I Renewable Generation Unit, and, to the extent that Buyer does not purchase any such REC or comparable certificate, credit, attribute or other similar product associated with the Facility, Seller may, in its sole discretion, sell, transfer or otherwise dispose of that REC or comparable certificate, credit, attribute or other similar product. In the event that the Buyer notifies Seller that it will not purchase any REC or comparable certificate, credit, attribute or other similar product produced by the Facility which fails to satisfy the RPS as an Environmental Attribute associated with the specified MWh of generation from a RPS Class I Renewable Generation Unit, then Buyer may resume purchasing such RECs or comparable certificates, credits, attributes or other similar products produced by the Facility that, at such time, Seller has not otherwise committed to sell to third-parties via an executed agreement, upon thirty (30) days' prior written notice to Seller, unless otherwise agreed by Buyer and Seller.

(c) During the Services Term, Seller shall Deliver Buyer's Percentage Entitlement of the Products produced by or associated with the Facility, up to and including the Contract Maximum Amount, exclusively to Buyer, and Seller shall not sell, divert, grant, transfer or assign such Products or any right, claim, certificate or other attribute associated with such Products to any Person other than Buyer during the Term: (a "Third Party Delivery"). Seller shall not enter into any agreement or arrangement under which such Products can be claimed by any Person other than Buyer. Buyer shall have the exclusive right to resell or convey the Products in its sole discretion. Notwithstanding the foregoing, nothing herein shall limit or restrict the right of Seller (a) to sell Energy and RECs and receive payment therefor in connection with (i) Energy, and RECs that are not Products, (ii) Rejected Purchases, or (iii) an exercise by Seller of its remedies under Section 9.3(a)(ii) or (b) to sell any capacity rights associated with the Facility for its own account and without any requirement of compensation or revenue crediting to the Buyer.

(d) Buyer shall not be obligated to accept or pay for Products during any period where Seller fails to satisfy, or cause to be satisfied, any material obligation under the ISO-NE Rules or ISO-NE Practices or any other obligation with respect to ISO-NE and such failure has an adverse effect on the Facility or Seller's ability to perform its obligations under this Agreement or on Buyer or Buyer's rights or ability to receive the benefits under this Agreement.

4.2 Scheduling and Delivery.

(a) During the Services Term and in accordance with Section 4.1, Seller shall Schedule and Deliver Energy hereunder with ISO-NE ~~within the defined Operational Limitations of the Facility and~~ in accordance with this Agreement and all ISO-NE Practices and ISO-NE Rules ~~to Buyer through Internal Bilateral Transactions executed through ISO-NE and settled at the Delivery Point, in accordance with all ISO-NE Practices and ISO-NE Rules. Any such Internal Bilateral Transactions will specify the hourly delivery of Energy and will be entered into daily, with any necessary adjustments being made pursuant to ISO-NE settlement protocols, and Seller shall transfer~~ will not receive any payment associated with a Marginal Loss Revenue Fund ~~allocation in connection with any such Internal Bilateral Transactions. Any such Internal Bilateral Transactions will be entered in the Energy to Buyer in the Day Ahead Energy Market or Real-Time Energy Market, as reasonably agreed from time to time by Buyer and Seller and~~ consistent with ISO-NE Rules and ISO-NE Practices at the time, and Buyer shall have no obligation to pay for any Energy not transferred to Buyer in the ~~Day Ahead Energy Market or Real-Time Energy Market or for which Buyer is not credited in the ISO-NE Settlement Market System (including, without limitation, as a result of an outage on any electric transmission system). Notwithstanding any other provision of this Agreement, if during the Services Term of this Agreement the LMP at the Delivery Point is negative, or, in the reasonable opinion of Seller, is likely to become negative, then Seller may deliver to Buyer a written notice stating that such condition has occurred or is likely to occur and the period during which such condition has occurred or is likely to occur.~~ then Buyer and Seller hereby agree that in such event Seller shall be under no obligation to ~~schedule~~ Schedule or Deliver Products to the Delivery Point during such period. Seller shall provide Buyer with ~~detailed information, including but not limited to, the start and stop times of such periods of curtailment under this Section 4.2(a) as well as the quantity curtailed,~~ for all such periods of ~~non-delivery~~ curtailment during the preceding calendar month, which information ~~shall~~ will be provided prior to Seller's delivery of the invoice to Buyer.

Formatted: Font color: Text 1, Pattern: Clear (White)

Formatted: Font color: Text 1

(b) The Parties agree to use commercially reasonable efforts to comply with all applicable ISO-NE Rules and ISO-NE Practices in connection with the Scheduling and Delivery of Energy hereunder. Without limiting the foregoing, Seller shall submit an Internal Bilateral Transaction for the Energy to be Delivered hereunder by the applicable scheduling deadline and Buyer shall confirm the Internal Bilateral Transaction submitted by Seller by the applicable scheduling deadline. Penalties or similar charges assessed by a Transmission Provider and caused by Seller's noncompliance with the Scheduling obligations set forth in this Section 4.2 shall be the responsibility of Seller.

(c) Without limiting the generality of this Section 4.2, Seller or the party with whom Seller contracts pursuant to Section 3.5(e) shall at all times during the Services Term be designated with ISO-NE as the "Lead Market Participant" (or any successor designation) for the

Facility and shall be solely responsible for any obligations and liabilities imposed by ISO-NE or under the ISO-NE Rules and ISO-NE Practices with respect to the Facility, including all charges, penalties, financial assurance obligations, losses, transmission charges, ancillary service charges, line losses, congestion charges and other ISO-NE or applicable system costs or charges associated with transmission. To the extent Buyer incurs such costs, charges, penalties or losses which are the responsibility of Seller, (including amounts not credited to Buyer as described in Section 4.2(a)), Seller shall reimburse Buyer for the same.

4.3 Failure of Seller to Deliver Products. In the event that Seller ~~completes a Third Party Delivery or Seller~~ fails to satisfy ~~any of its Delivery obligations to Deliver any of the Products or any portion of the Products hereunder [during the Services Term]~~ in accordance with Section 4.1, Section 4.2 and Section 4.7, and such failure is not excused under the express terms of this Agreement (a "**Delivery Failure**"), Seller shall pay Buyer an amount for such Delivery Failure (measured in MWh and/or RECs) equal to the Cover Damages for such Delivery Failure. Such payment shall be due no later than the date for Buyer's payment for the applicable month as set forth in Section 5.2 hereof. Each Party agrees and acknowledges that (i) the damages that Buyer would incur due to a Delivery Failure would be difficult or impossible to predict with certainty, and (ii) it is impractical and difficult to assess actual damages in the circumstances stated, and therefore the Cover Damages as agreed to by the Parties and set forth herein is a fair and reasonable calculation of such damages.

4.4 Failure by Buyer to Accept Delivery of Products. If Buyer fails to accept all or part of any of the Products to be purchased by Buyer hereunder, and such failure to accept (a) is not the result of Reliability Curtailment or (b) is not otherwise excused under the terms of this Agreement (a "**Rejected Purchase**"), then Buyer shall pay Seller, on the date payment would otherwise be due in respect of the month in which the failure occurred, an amount for such Rejected Purchase equal to the Resale Damages. Each Party agrees and acknowledges that (i) the damages that Seller would incur due to a Rejected Purchase would be difficult or impossible to predict with certainty, and (ii) it is impractical and difficult to assess actual damages in the circumstances stated, and therefore the Resale Damages as agreed to by the Parties and set forth herein is a fair and reasonable calculation of such damages.

4.5 Delivery Point.

(a) All Energy shall be Delivered hereunder by Seller to Buyer at the Delivery Point. Seller shall be responsible for the costs of delivering its Energy to the Delivery Point consistent with all standards and requirements set forth by the FERC, ISO-NE, and any other applicable Governmental Entity or applicable tariff.

(b) Seller shall be responsible for all applicable charges associated with transmission and interconnection service and delivery charges, including all related ISO NE administrative fees, uplift, socialized charges, all costs for Network Upgrades, ~~fall costs for Related Transmission Facilities,~~ and all other charges in connection with the satisfaction of Seller's obligations hereunder, including without limitation the Delivery of Energy to and at the Delivery Point. Seller shall have no responsibility for applicable charges associated with transmission and interconnection service and delivery charges, including all ISO-NE administrative fees, uplift, socialized charges, and all other charges in connection with the

transmission and/or delivery of Energy after the Delivery Point. Seller shall indemnify and hold harmless Buyer, in accordance with the provisions of Article 13, for any such charges, fees, costs or expenses imposed upon Buyer by operation of ISO-NE rules or otherwise in connection with Seller's performance of its obligations hereunder.

4.6 Metering.

(a) Metering. All electric metering associated with the Facility, including the Facility meter and any other real-time meters, billing meters and back-up meters (collectively, the "Meters"), shall be installed, operated, maintained and tested at Seller's expense in accordance with Good Utility Practice and any applicable requirements and standards issued by NERC, the Interconnecting Utility, and ISO-NE; ~~provided that each Meter shall be tested at Seller's expense once each Contract Year, including ISO-NE Operating Procedure No. 18 for meter installation, accuracy and instrument transformers.~~ All Meters used to provide data for the computation of payments shall be revenue quality Meters and shall be sealed, and Seller shall break the seal only when such Meters are to be inspected and tested (or adjusted) in accordance with this Section 4.6. Seller shall provide Buyer with a copy of all metering and calibration information and documents regarding the Meters promptly following receipt thereof by Seller.

(b) Measurements. Readings of the Meters at the ~~Facility~~ Delivery Point by the Interconnecting Utility in whose territory the Facility ~~is and the Other Facility are~~ located (or an independent Person mutually acceptable to the Parties) shall be conclusive as to the amount of Energy ~~generated~~ Delivered by the Facility; ~~and the Other Facility, collectively, and readings of the Meters installed prior to the electrical service platform serving the Facility and the Other Facility shall be conclusive as to the allocation of Energy Delivered by the Facility and the Other Facility, as~~ provided ~~however, that in Exhibit E.~~ Seller, upon request of Buyer and at Buyer's expense (if more frequently than ~~annually~~ as provided for in Section 4.6(~~ad~~)), shall cause the Meters to be tested by the Interconnecting Utility in whose territory the Facility is located; ~~(or an independent Person mutually acceptable to the Parties),~~ and if any Meter is out of service or is determined to be registering inaccurately by more than two percent (2%), (i) the measurement of Energy produced by the Facility shall be adjusted as far back as can reasonably be ascertained, but in no event shall such period exceed six (6) months from the date that such inaccuracy was discovered, in accordance with the filed tariff of such Interconnecting Utility or the ISO-NE Tariff, whichever is applicable, and any adjustment shall be reflected in the next invoice provided by Seller to Buyer hereunder and (ii) Seller shall reimburse Buyer for the cost of such test of the Meters. Meter readings shall be adjusted to take into account the losses to Deliver the Energy to the Delivery Point. Seller shall make recorded meter data available monthly to the Buyer at no cost.

~~(c) Inspection, Testing and Calibration. Allocation of Energy between the Facility and the Other Facility. The Parties acknowledge and agree that the Energy produced by the Facility and the Other Facility will not be capable of separate metering at the Delivery Point, and the Energy generated in any hour (or shorter settlement period applicably under the ISO-NE Rules) by the Facility and the Other Facility (including any Energy not included in the Products or the Products being purchased under the Other Facility Agreement) will be allocated between the Facility and the Other Facility, and attributed to Energy being purchased by Buyer hereunder and under the Other Facility Agreement, pursuant to the process described in Exhibit E.~~

~~(e)~~(d) Inspection, Testing and Calibration. Each Meter shall be tested at Seller's expense in accordance with the requirements of ISO-NE Operating Procedure No. 18 with respect to frequency, method and test points; provided, however, that, notwithstanding the provisions of any ISO-NE Rules or ISO-NE Practices, Buyer may require that each Meter be tested at Seller's expense once each Contract Year. Seller shall notify Buyer and coordinate such testing to allow for witnessing by Buyer, and the testing company will provide written reports of all testing results to Buyer. Buyer shall have the right to inspect and test (at its own expense) any of the Meters at the Facility at reasonable times and upon reasonable (but in any event, no less than 14 days') notice from Buyer to Seller in coordination with the Interconnecting Utility. Buyer shall have the right to have a representative present during any testing or calibration of the Meters at the Facility by Seller. ~~Seller shall provide Buyer with timely notice of any such testing or calibration in coordination with the Interconnecting Utility.~~ Seller shall provide Buyer with timely notice of any such testing or calibration. Any representative of Buyer performing a Meter inspection shall undergo Seller provided training prior to such representative's initial inspection. During any inspection, testing, or calibration of the Meters, Buyer shall be subject to Seller's and its contractors' reasonable site access rules and any safety Laws applicable to the site where the Facility is located. Buyer shall be accompanied by a Seller representative for any Meter inspection.

~~(d)~~(e) Audit of Meters. Buyer shall have ~~access to the Meters and~~ the right to audit all information and test data related to ~~such~~the Meters.

~~(e)~~(f) Notice of Malfunction. Seller shall provide Buyer with prompt notice of any malfunction or other failure of the Meters or other telemetry equipment necessary to accurately report the quantity of Energy being produced by the Facility. If any Meter is found to be inaccurate by more than two percent (2%), the meter readings shall be adjusted as far back as can reasonably be ascertained, but in no event shall such period exceed six (6) months from the date that such inaccuracy was discovered, and any adjustment shall be reflected in the next invoice provided by Seller to Buyer hereunder.

~~(f)~~(g) Telemetry. The Meters shall be capable of sending meter telemetry data, and Seller shall provide Buyer with simultaneous access to such data at no additional cost to Buyer. This provision is in addition to Seller's requirements under ISO-NE Rules and Practices, including ISO-NE Operating Procedure No. 18.

~~*[For Facilities located outside the ISO-NE area, the EDCs will provide language regarding metering at the Interconnection Point and measuring Energy Deliveries at the Delivery Point]*~~

4.7 RECs.

~~*[LANGUAGE FOR TRANSFER OF RECS FOR SERVICES TERM]*~~

(a) Seller shall transfer to Buyer all of the right, title and interest in and to Buyer's Percentage Entitlement of the -Environmental Attributes, including any and all RECs, generated by, or associated with, the Facility during the Services Term in accordance with the terms of this Section 4.7.

(b) Regarding the RPS:

- (i) Except as provided in subsection (ii) of this Section 4.7(b), all Energy provided by Seller to Buyer from the Facility under this Agreement shall meet the requirements for eligibility pursuant to the RPS, and Seller's failure to satisfy such requirements shall constitute an Event of Default pursuant to Section 9.1-(c) of this Agreement except as provided in Section 4.7(b)(ii), below; and
- (ii) It shall not be an Event of Default under Article 9 if, solely as a result of change in Law, Energy provided by Seller to Buyer from the Facility under this Agreement no longer meets the requirements for eligibility pursuant to the RPS, provided Seller promptly uses commercially reasonable efforts to ensure that qualification will continue after the change in Law. If, notwithstanding such commercially reasonable efforts and solely as a result of change in Law, the Facility does not qualify as a RPS Class I Renewable Generation Unit, then (A) Seller shall continue to sell, and Buyer shall continue to purchase Energy under this Agreement ~~at the Price for such Energy—Generic~~ ~~at the Adjusted Price—National Grid~~ in accordance with Section 5.1 and (B) any purchases and sales of RECs shall be in accordance with Section 4.1(b).

(c) At Seller's sole cost, Seller shall also obtain and maintain throughout the Services Term qualification as a RPS Class I generation resource under the renewable portfolio standard or similar law of the New England states of Connecticut, Maine, Massachusetts, New Hampshire, and Rhode Island, to the extent the renewable energy technology used in the Facility is eligible under such renewable portfolio standard or similar law. At Buyer's request and at Seller's sole cost, Seller shall also obtain qualification under the renewable portfolio standard or similar law of New York and/or any federal renewable energy standard, to the extent the renewable energy technology used in the Facility is eligible under such renewable portfolio standard, renewable energy standard or similar law; (the "Additional RECs"), and Seller shall use commercially reasonable efforts, consistent with Good Utility Practice, to maintain such qualifications at all times during the Services Term unless otherwise agreed by Buyer. It shall not be an Event of Default under this Agreement if, solely as a result of change in Law, Seller fails to maintain or, with respect to the Additional RECs only, obtain, the qualifications required by this Section 4.7(c), provided Seller promptly uses commercially reasonable efforts to ensure that obtaining and maintaining such qualification will continue after the change in Law. Seller shall also submit to Buyer or as directed by Buyer any information required by any state or federal agency with regard to administration of its rules regarding Environmental Attributes or its renewable energy standard or renewable portfolio standard or Seller's qualification under the foregoing. Notwithstanding the foregoing, nothing in this Section 4.7(c) shall require Seller to Deliver Energy to any location other than at the Delivery Point.

(d) Seller shall comply with all GIS Operating Rules, including without limitation such Rules relating to the creation, tracking, recording and transfer of all RECs to be purchased by Buyer under this Agreement. In addition, at Buyer's request, Seller shall register with and comply with the rules and requirements of any other tracking system or program that

tracks, monetizes or otherwise creates or enhances value for Environmental Attributes, which compliance shall be at Seller's sole cost if such registration and compliance is requested in connection with Section 4.7(c) above and shall be at Buyer's sole cost in other instances.

(e) Prior to the delivery of any Energy hereunder ~~(including any Energy Delivered during the Test Period),~~ either (i) Seller shall cause Buyer to be registered in the GIS as the initial owner of all Certificates to be Delivered hereunder to Buyer or (ii) Seller and Buyer shall effect an irrevocable Forward Certificate Transfer (as defined in the GIS Operating Rules) of the Certificates to be Delivered hereunder to Buyer in the GIS for the ~~Test Period and the Services Term~~; provided, however, that no payment shall be due to Seller for any RECs until either (x) the Certificates are actually deposited in Buyer's GIS account or a GIS account designated by Buyer to Seller in writing, or (y) (i) Buyer and Seller enter such an irrevocable Forward Certificate Transfer of the Certificates to be Delivered to Buyer in the GIS, which Forward Certificate Transfer shall be denoted in the GIS as not being capable of rescission by Seller, and (ii) the Energy with which such RECs are associated has been Delivered to Buyer.

(f) The Parties intend for the transactions entered into hereunder to be physically settled, meaning that the RECs are intended to be Delivered in the GIS account of Buyer or its designee as set forth in this Section 4.7.

~~[ALTERNATIVE LANGUAGE FOR TRANSFER OF ENTITLEMENT TO ATTRIBUTES]~~

~~(a) — Seller hereby transfers, assigns and conveys to Buyer, its successors and assigns, an undivided ownership interest in and entitlement to [all of] the RECs, including without limitation any and all [associated] Certificates, regardless of whether those RECs and/or Certificates are associated with Energy generated before, during or after the Services Term; provided, however, that Buyer shall have no ownership interest or entitlement in any RECs associated with generation occurring after [];~~

~~(b) — All Energy and RECs Delivered to Buyer under this Agreement during the Services Term shall meet the requirements for eligibility pursuant to the RPS, and Seller's failure to satisfy such requirements shall constitute an Event of Default pursuant to Section 9.1(c) of this Agreement; provided, however, it shall not be an Event of Default if, solely as a result of change in Law, Energy provided by Seller to Buyer from such Facility no longer meets the requirements for eligibility pursuant to the RPS so long as Seller promptly uses commercially reasonable efforts to ensure that qualification will continue after the change in Law. If, notwithstanding such commercially reasonable efforts and solely as a result of change in Law, that Facility does not qualify as a RPS Class I Renewable Generation Unit, then (A) Seller shall continue to sell, and Buyer shall continue to purchase Energy under this Agreement [at the Price for such Energy — Generic] [at the Adjusted Price — National Grid]. Seller makes no representation or warranty with respect to any RECs Delivered after the expiration of the Services Term.~~

~~(c) — Seller shall take all actions requested by Buyer to reflect the transfer described in Section 4.7(a) above, including without limitation all actions required under the GIS Operating Rules including without limitation such Rules relating to the creation, tracking, recording and transfer of all RECs [transferred hereunder]. In addition, at Buyer's request, Seller register with and take such actions required under the rules and requirements of any other tracking system or~~

~~program that tracks, monetizes or otherwise creates or enhances value for RECs in order to reflect the transfer described in Section 4.7(a), which compliance shall be at Seller's sole cost.~~

~~(d) — Without limiting the generality of the foregoing, prior to the delivery of any Energy hereunder, [either (i) Seller shall cause Buyer to be registered in the GIS and any other applicable tracking system or program as the initial owner of all RECs, including the associated Certificates, or (ii)] Seller and Buyer shall effect an irrevocable Forward Certificate Transfer (as defined in the GIS Operating Rules) of the RECs and any associated Certificates [to be transferred to Buyer hereunder].~~

~~(e) — Each Party shall execute and deliver such additional instruments of transfer, conveyance, assignment and confirmation and take such additional action as is necessary to transfer, convey and assign the RECs to Buyer in accordance with the terms hereof.~~

~~(f) — The Parties intend for the transactions entered into hereunder to be physically settled, meaning that the RECs are intended to be Delivered in the GIS account of Buyer or its designee as set forth in this Section 4.7.~~

~~(g) — At Seller's sole cost, Seller shall also obtain and maintain throughout the Services Term qualification as a RPS Class I generation resource under the renewable portfolio standard or similar law of the New England states of Connecticut, Maine, Massachusetts, New Hampshire, and Rhode Island, to the extent the renewable energy technology used in the Facility is eligible under such renewable portfolio standard or similar law. At Buyer's request and at Seller's sole cost, Seller shall also obtain qualification under the renewable portfolio standard or similar law of New York and/or any federal renewable energy standard, to the extent the renewable energy technology used in the Facility is eligible under such renewable portfolio standard, renewable energy standard or similar law, and Seller shall use commercially reasonable efforts, consistent with Good Utility Practice, to maintain such qualifications at all times during the Services Term unless otherwise agreed by Buyer. Seller shall also submit to Buyer or as directed by Buyer any information required by any state or federal agency with regard to administration of its rules regarding Environmental Attributes or its renewable energy standard or renewable portfolio standard or Seller's qualification under the foregoing. Seller shall comply with all GIS Operating Rules including without limitation such Rules relating to the creation, tracking, recording and transfer of all Environmental Attributes to be purchased by Buyer under this Agreement. In addition, at Buyer's request, Seller register with and comply with the rules and requirements of any other tracking system or program that tracks, monetizes or otherwise creates or enhances value for Environmental Attributes, which compliance shall be at Seller's sole cost.~~

~~4.8 — Deliveries During Test Period. During the Test Period, Seller shall sell and Deliver, and Buyer shall purchase and receive Buyer's Percentage Entitlement of any Energy ("**Test Energy**") [and RECs] produced by or associated with the Facility. Notwithstanding the provisions of Section 5.1, payment for Test Energy Delivered during the Test Period [and RECs associated with such Test Energy] shall be equal to one hundred percent (100%) of the product of (x) the Test Energy Delivered (in MWh) and (y) the lesser of (i) the Price for Energy determined in accordance with Section 1(a) of Exhibit D for Year 1, or (ii) the Real Time LMP at such Delivery Point. In the event that the Real Time LMP for the Test Energy at the Delivery~~

~~Point is less than \$0.00 per MWh in any hour, Seller shall credit to Buyer, on the appropriate monthly invoice, an amount equal to one hundred percent (100%) of the product of (i) such Test Energy delivered in such hour and (ii) the absolute value of the hourly Real Time LMP at the Delivery Point. In no event shall the Test Period extend beyond six (6) months, except due to Force Majeure.~~

4.8 Production During Test Period. During the Test Period, Seller shall not sell and Deliver to Buyer, and Buyer shall not purchase and receive any Energy or REC's produced by or associated with the Facility.

Formatted: Outline numbered + Level: 2 + Numbering Style: 1, 2, 3, ... + Start at: 1 + Alignment: Left + Aligned at: 0.5" + Tab after: 0" + Indent at: 0", Tab stops: 1", List tab + Not at 0"
Formatted: Font: Bold, Underline, Font color: Auto

5. PRICE AND PAYMENTS FOR PRODUCTS

5.1 Price for Products. All Products Delivered to Buyer in accordance with this Agreement shall be purchased by Buyer at the Price specified in Exhibit D; provided, however, that if the REC's fail to satisfy the RPS as an Environmental Attribute associated with the specified MWh of generation from a RPS Class I Renewable Generation Unit and Buyer does not purchase the REC's pursuant to Section 4.1(b), then all Energy Delivered to Buyer in accordance with this Agreement shall be purchased by Buyer at the Price for Energy only, ~~as specified in Exhibit D. [The Parties acknowledge and agree that the price includes the amortization over the Services Term of the cost for the transfer of the Environmental Attributes described in Section 4.7.] [Alternative REC Delivery Language] specified in Exhibit D.~~ Other than the (i) payment for the Products under this Section 5.1, (ii) payments related to Meter testing under Section 4.6(b), (iii) payments related to Meter malfunctions under Section 4.6(e), (iv) payment ~~for Energy and REC's during the Test Period in accordance with Section 4.8,~~ (v) ~~payment of~~ any Resale Damages under Section 4.4, (vi) payment of interest on late payments under Section 5.3, (vii) payments for reimbursement of Buyer's Taxes under Section 5.4(a), (viii) return of any Credit Support under Sections 6.1 and 6.3, (viii) causing interest incurred on Cash deposits to be remitted to Seller in accordance with Section 6.3, and (ix) payment of any Termination Payment due from Buyer under Section 9.3, Buyer shall not be required to make any other payments to Seller under this Agreement, and Seller shall be solely responsible for all costs and losses incurred by it in connection with the performance of its obligations under this Agreement. In the event that the LMP for the Energy at the Delivery Point is less than \$0.00 per MWh ~~in~~for any hour, Seller shall credit to Buyer, on the appropriate monthly invoice, an amount equal to the product of (i) such Energy delivered in such hour (if any) and (ii) the absolute value of the hourly LMP at the Delivery Point.

Formatted: Font: Not Bold, Not Italic

5.2 Payment and Netting.

(a) Billing Period. The calendar month shall be the standard period for all charges and payments under this Agreement. On or before the fifteenth (15th) day following the end of each month, Seller shall render to Buyer an invoice for the payment obligations incurred hereunder during the preceding month, based on the Energy Delivered in the preceding month, and any REC's deposited in Buyer's GIS account or a GIS account designated by Buyer to Seller in writing in the preceding month. Such invoice shall contain supporting detail for all charges reflected on the invoice, and Seller shall provide Buyer with additional supporting documentation and information as Buyer may request.

(b) Timeliness of Payment. All undisputed charges shall be due and payable in accordance with each Party's invoice instructions on or before the later of (x) fifteen (15) days from receipt of the applicable invoice or (y) the last day of the calendar month in which the applicable invoice was received (or in either event the next Business Day if such day is not a Business Day). Each Party shall make payments by electronic funds transfer, or by other mutually agreeable method(s), to the account designated by the other Party. Any undisputed amounts not paid by the due date shall be deemed delinquent and shall accrue interest at the Late Payment Rate, such interest to be calculated from and including the due date to but excluding the date the delinquent amount is paid in full.

(c) Disputes and Adjustments of Invoices.

- (i) All invoices rendered under this Agreement shall be subject to adjustment after the end of each month in order to true-up charges based on changes resulting from ISO-NE billing statements or revisions, if any, to previous ISO-NE billing statements. If ISO-NE resettles any invoice which relates to the Products sold under this Agreement and (a) any charges thereunder are the responsibility of the other Party under this Agreement or (b) any credits issued thereunder would be due to the other Party under this Agreement, then the Party receiving the invoice from ISO-NE shall in the case of (a) above invoice the other Party or in the case of (b) above pay the amount due to the other Party. Any invoices issued or amounts due pursuant to this Section shall be invoiced or paid as provided in this Section 5.2.
- (ii) Within twelve (12) months of the issuance of an invoice the Seller shall adjust any invoice for any arithmetic or computational error and shall provide documentation and information supporting such adjustment to Buyer. Within twelve (12) months of the receipt of an invoice (or an adjusted invoice), the Buyer may dispute any charges on that invoice. In the event of such a dispute, the Buyer shall give notice to the Seller and shall state the basis for the dispute. Payment of the disputed amount shall not be required until the dispute is resolved. Upon resolution of the dispute, any required payment or refund shall be made within ten (10) days of such resolution along with interest accrued at the Late Payment Rate from and including the due date (or in the case of a refund, the payment date) but excluding the date paid. Any claim for additional payment is waived unless the Seller issues an adjusted invoice within twelve (12) months of issuance of the original invoice. Any dispute of charges is waived unless the Buyer provides notice of the dispute to the Seller within twelve (12) months of receipt of the invoice (or adjusted invoice) including such charges.

(d) Netting of Payments. The Parties hereby agree that they may discharge mutual debts and payment obligations due and owing to each other under this Agreement on the same date through netting of such monetary obligations, in which case all amounts owed by each Party to the other Party for the purchase and sale of Products during the monthly billing period under this Agreement, including any related damages calculated pursuant to this Agreement, interest, and payments or credits, may be netted so that only the excess amount remaining due shall be paid by the Party who owes it. If no mutual debts or payment obligations exist and only one Party owes a debt or obligation to the other during the monthly billing period, such Party shall pay such sum in full when due. The Parties agree to provide each other with reasonable detail of such net payment or net payment request.

Formatted: No underline

5.3 Interest on Late Payment or Refund. A late payment charge shall accrue on any late payment or refund as specified above herein at the lesser of (a) the prime rate specified in the "Money & Investing" section of The Wall Street Journal (or, if such rate is not published therein, in a successor index mutually selected by the Parties) plus 1% per cent, and (b) the maximum rate permitted by applicable Law in transactions involving entities having the same characteristics as the Parties (the "Late Payment Rate").

5.4 Taxes, Fees and Levies.

(a) Seller shall be obligated to pay all present and future taxes, fees and levies, imposed on or associated with the Facility or ~~delivery~~Delivery or sale of the Products ("Seller's Taxes"). Buyer shall be obligated to pay all present and future taxes, fees and levies, imposed on or associated with such Products after Delivery of such Products to Buyer, or imposed on or associated with the purchase of such Products by Buyer (other than ad valorem, franchise or income taxes which are related to the sale of the Products and are, therefore, the responsibility of Seller) ("Buyer's Taxes"). In the event Seller shall be required by law or regulation to remit or pay any Buyer's Taxes, Buyer shall reimburse Seller for such payment. In the event Buyer shall be required by law or regulation to remit or pay any Seller's Taxes, Seller shall reimburse Buyer for such payment, and Buyer may also elect to deduct any of the amount of any such Seller's Taxes from the amount due to Seller under Section 5.2. Buyer shall have the right to all credits, deductions and other benefits associated with taxes paid by Buyer or reimbursed to Seller by Buyer as described herein. Nothing shall obligate or cause a Party to pay or be liable to pay any taxes, fees and levies for which it is exempt under law.

(b) Seller shall bear all risks, financial and otherwise, throughout the Term, associated with Seller's or the Facility's eligibility to receive any federal or state tax credits, to qualify for accelerated depreciation for Seller's accounting, reporting or tax purposes, or to receive any other favorable tax or accounting right or benefit, or any grant or subsidy from a Governmental Entity or other Person. Seller's obligations under this Agreement shall be effective regardless of whether the Facility is eligible for or receives, or the transactions contemplated under this Agreement are eligible for or receives, any federal or state tax credits, grants or other subsidies or any particular accounting, reporting or tax treatment.

Formatted: No underline

6. SECURITY FOR PERFORMANCE

6.1 Seller's Support.

Formatted: No underline

Formatted: Don't keep with next

(a) Seller shall be required to post Credit Support in the total amount of ~~[\$_____]~~ [\$4,228,000 (which is equal to \$20,000.00 per MWh per hour of the Contract Maximum Amount)], as adjusted in accordance with Section 3.1(c), to secure Seller's obligations in the period between the Effective Date and the Commercial Operation Date ("**Development Period Security**"). ~~Fifty percent (50%)~~ \$2,114,000 of the Development Period Security (which is equal to \$10,000.00 per MWh per hour of the Contract Maximum Amount) shall be provided to Buyer on the Effective Date; and ~~the remaining fifty percent (50%)~~ \$2,114,000 of the Development Period Security (which is equal to \$10,000.00 per MWh per hour of the Contract Maximum Amount) shall be provided to Buyer within fifteen (15) Business Days after receipt of the Regulatory Approval. If at any time, the amount of Development Period Security is reduced as a result of Buyer's draw upon such Development Period Security to less than the amount of Development Period Security required to be provided by Seller, within [REDACTED] of that draw Seller shall replenish such Development Period Security to the amount of Development Period Security required to be provided by Seller through the period ending fifteen (15) days after receipt of the Regulatory Approval. Buyer shall return any undrawn amount of the Development Period Security to Seller within thirty (30) days after the later of (x) Buyer's receipt of an undisputed notice from Seller that the Commercial Operation Date has occurred or (y) Buyer's receipt of the full amount of the Operating Period Security (except to the extent that Development Period Security is converted into Operating Period Security as provided in Section 6.1(b)).

(b) Beginning not later than ten (10) days following the Commercial Operation Date, Seller shall provide Buyer with Credit Support to secure Seller's obligations under this Agreement after the Commercial Operation Date through and including the date that all of Seller's obligations under this Agreement are satisfied ("**Operating Period Security**"). The Operating Period Security shall be in the amount of ~~[\$_____]~~ [\$4,228,000 (which is equal to \$20,000.00 per MWh per hour of the Contract Maximum Amount)], as adjusted in accordance with Section 3.3(b). If at any time on or after the Commercial Operation Date, the amount of Operating Period Security is reduced as a result of Buyer's draw upon such Operating Period Security, [REDACTED] of that draw Seller shall replenish such Operating Period Security to the total amount required under this Section 6.1(b).

6.2 Cash Deposits. Any ~~cash~~ Cash provided by Seller as Credit Support under this Agreement shall be held in an account selected by Buyer in its reasonable discretion. Interest shall accrue on that ~~cash~~ Cash deposit at the daily Federal Funds Rate and shall be remitted to Seller upon written request to Buyer, with such request not more often than on a quarterly basis and Buyer shall remit such accrued interest to the Seller within a reasonable time following receipt of such request. Seller agrees to comply with the commercially reasonable requirements of Buyer in connection with the receipt and retention of any ~~cash~~ Cash provided as Credit Support under this Agreement.

6.3 Return of Credit Support. Any unused Credit Support provided under this Agreement shall be returned to Seller only after any such Credit Support has been used to satisfy any outstanding obligations of Seller in existence at the time of the expiration or termination of this Agreement.

~~6.4~~

6.4 Buyer's Rights and Remedies. If at any time an Event of Default with respect to Seller has occurred and is continuing, then, unless Seller has paid in full all of its obligations hereunder that are then due, without limiting any other rights and remedies Buyer may have under this Agreement or otherwise at law or in equity, Buyer may exercise one or more of the following rights and remedies: (i) all rights and remedies available to a secured party under applicable Law with respect to Credit Support held by Buyer, and (ii) the right to liquidate any Credit Support held by Buyer and to apply the proceeds of such liquidation to any amounts payable to Buyer with respect to Seller's obligations hereunder in such order as Buyer may elect. For the purpose of this Section 6.4, Buyer may draw on the undrawn portion of any ~~letter~~Letter of ~~credit~~Credit provided as Credit Support up to the amount of Seller's outstanding obligations hereunder. Seller shall remain liable for amounts due and owed to Buyer that remain unpaid after the application of Credit Support pursuant to this Section 6.4.

7. REPRESENTATIONS, WARRANTIES, COVENANTS AND ACKNOWLEDGEMENTS

7.1 Representations and Warranties of Buyer. Buyer hereby represents and warrants to Seller as follows:

(a) Organization and Good Standing; Power and Authority. Buyer is a corporation duly incorporated, validly existing and in good standing under the laws of the Commonwealth of Massachusetts. Subject to the receipt of the Regulatory Approval, Buyer has all requisite power and authority to execute, deliver, and perform its obligations under this Agreement.

(b) Due Authorization; No Conflicts. The execution and delivery by Buyer of this Agreement, and the performance by Buyer of its obligations hereunder, have been duly authorized by all necessary actions on the part of Buyer and do not and, under existing facts and Law, shall not: (i) contravene its certificate of incorporation or any other governing documents; (ii) conflict with, result in a breach of, or constitute a default under any note, bond, mortgage, indenture, deed of trust, license, contract or other agreement to which it is a party or by which any of its properties may be bound or affected; (iii) subject to receipt of the Regulatory Approval, violate any order, writ, injunction, decree, judgment, award, statute, law, rule, regulation or ordinance of any Governmental Entity or agency applicable to it or any of its properties; or (iv) result in the creation of any lien, charge or encumbrance upon any of its properties pursuant to any of the foregoing.

(c) Binding Agreement. This Agreement has been duly executed and delivered on behalf of Buyer and, assuming the due execution hereof and performance hereunder by Seller and receipt of the Regulatory Approval, constitutes a legal, valid and binding obligation of Buyer, enforceable against it in accordance with its terms, except as such enforceability may be limited by law or principles of equity.

(d) No Proceedings. As of the Effective Date, except to the extent relating to the Regulatory Approval, there are no actions, suits or other proceedings, at law or in equity, by

or before any Governmental Entity or agency or any other body pending or, to the best of its knowledge, threatened against or affecting Buyer or any of its properties (including, without limitation, this Agreement) which relate in any manner to this Agreement or any transaction contemplated hereby, or which Buyer reasonably expects to lead to a material adverse effect on (i) the validity or enforceability of this Agreement or (ii) Buyer's ability to perform its obligations under this Agreement

[REDACTED]

(e) Consents and Approvals. Except to the extent associated with the Regulatory Approval, the execution, delivery and performance by Buyer of its obligations under this Agreement do not and, under existing facts and Law, shall not, require any Permit or any other action by, any Person which has not been duly obtained, made or taken or that shall be duly obtained, made or taken on or prior to the date required, and all such approvals, consents, permits, licenses, authorizations, filings, registrations and actions are in full force and effect, final and non-appealable as required under applicable Law.

(f) Negotiations. The terms and provisions of this Agreement are the result of arm's length and good faith negotiations on the part of Buyer and equal bargaining power of the Parties. No principle of law or equity regarding construing ambiguities in this Agreement against the drafting Party shall apply.

(g) Bankruptcy. There are no bankruptcy, insolvency, reorganization, receivership or other such proceedings pending against or being contemplated by Buyer, or, to Buyer's knowledge, threatened against it.

(h) No Default. No Default or Event of Default has occurred and is continuing and no Default or Event of Default shall occur as a result of the performance by Buyer of its obligations under this Agreement.

7.2 Representations and Warranties of Seller. Seller hereby represents and warrants to Buyer as of the Effective Date as follows:

(a) Organization and Good Standing; Power and Authority. Seller is a [REDACTED], limited liability company, duly formed, validly existing and in good standing under the laws of [REDACTED], the state of Delaware. Subject to the receipt of the Permits listed in Exhibit B ~~and any Related Transmission Approvals~~, Seller has all requisite power and authority to execute, deliver, and perform its obligations under this Agreement.

(b) Authority. Seller (i) has the power and authority to own and operate its businesses and properties, to own or lease the property it occupies and to conduct the business in which it is currently engaged; (ii) is duly qualified and in good standing under the laws of each jurisdiction where its ownership, lease or operation of property or the conduct of its business

requires such qualification; and (iii) holds, or shall hold as and when required to perform its obligations under this Agreement, all rights and entitlements necessary to construct, own and operate the Facility and to deliver the Products to the Buyer in accordance with this Agreement.

(c) Due Authorization; No Conflicts. The execution and delivery by Seller of this Agreement, and the performance by Seller of its obligations hereunder, have been duly authorized by all necessary actions on the part of Seller and do not and, under existing facts and Law, shall not: (i) contravene any of its governing documents; (ii) conflict with, result in a breach of, or constitute a default under any note, bond, mortgage, indenture, deed of trust, license, contract or other agreement to which it is a party or by which any of its properties may be bound or affected; (iii) assuming receipt of the Permits listed on Exhibit B ~~and any Related Transmission Approvals~~, violate any order, writ, injunction, decree, judgment, award, statute, law, rule, regulation or ordinance of any Governmental Entity or agency applicable to it or any of its properties; or (iv) result in the creation of any lien, charge or encumbrance upon any of its properties pursuant to any of the foregoing. Seller is, or shall be by the Commercial Operation Date, qualified to perform as a Market Participant under the ISO-NE Tariff, or is qualified to transact through another Market Participant under the ISO-NE Tariff. Seller will not be disqualified from or be materially adversely affected in the performance of any of its obligations under this Agreement by reason of market power or affiliate transaction issues under federal or state regulatory requirements.

(d) Binding Agreement. This Agreement has been duly executed and delivered on behalf of Seller and, assuming the due execution hereof and performance hereunder by Buyer and receipt of the Permits listed on Exhibit B ~~and any Related Transmission Approvals~~, constitutes a legal, valid and binding obligation of Seller, enforceable against it in accordance with its terms, except as such enforceability may be limited by law or principles of equity.

(e) No Proceedings. ~~Except As of the Effective Date, except~~ to the extent associated with the Regulatory Approval, the Permits listed on Exhibit B ~~and any Related Transmission Approvals~~, there are no actions, suits or other proceedings, at law or in equity, by or before any Governmental Entity or agency or any other body pending or, to the best of its knowledge, threatened against or affecting Seller or any of its properties (including, without limitation, this Agreement) which relate in any manner to this Agreement or any transaction contemplated hereby, ~~or~~ which Seller reasonably expects to lead to a material adverse effect on (i) the validity or enforceability of this Agreement or (ii) Seller's ability to perform its obligations under this Agreement

[REDACTED]

(f) Consents and Approvals. Subject to the receipt of the Permits listed on Exhibit B on or prior to the date such Permits are required under applicable Law ~~and subject to the receipt of the Related Transmission Approvals on or prior to the date such Related Transmission Approvals are required under Applicable Law~~, the execution, delivery and

performance by Seller of its obligations under this Agreement do not and, under existing facts and Law, shall not, require any Permit or any other action by, any Person which has not been duly obtained, made or taken, and all such approvals, consents, permits, licenses, authorizations, filings, registrations and actions are in full force and effect, final and non-appealable. To Seller's knowledge, Seller shall be able to receive the Permits listed in Exhibit B ~~and the Related Transmission Approvals~~ in due course and as required under applicable Law to the extent that those Permits have not previously been received.

(g) RPS Class I Renewable Generation Unit. The Facility shall be a RPS Class I Renewable Generation Unit, qualified by the DOER as eligible to participate in the RPS program, under Section 11F of Chapter 25A (subject to Section 4.7(b) in the event of a change in Law affecting such qualification as a RPS Class I Renewable Generation Unit) ~~and shall have a Commercial Operation Date as verified by the Buyer.~~

(h) Title to Products. Seller has and shall have good and marketable title to all Products sold and Delivered to Buyer under this Agreement, free and clear of all liens, charges and encumbrances. Seller has not sold and, except as permitted in accordance with the terms of this Agreement, shall not sell any such Products to any other Person, and no Person other than Seller can claim an interest in any Product to be sold to Buyer under this Agreement.

(i) Negotiations. The terms and provisions of this Agreement are the result of arm's length and good faith negotiations on the part of Seller and equal bargaining power of the Parties. No principle of law or equity regarding construing ambiguities in this Agreement against the drafting Party shall apply.

(j) Bankruptcy. There are no bankruptcy, insolvency, reorganization, receivership or other such proceedings pending against or being contemplated by Seller, or, to Seller's knowledge, threatened against it.

(k) No Misrepresentations. ~~The reports and other submittals by Seller to Buyer under this Agreement are not false or misleading in any material respect.~~ Misrepresentation. No reports or other submittals required to be furnished by or on behalf of the Seller pursuant to the terms of this Agreement, taken as a whole, shall contain an untrue statement of a material fact, or omits to state any material fact necessary to make the statements contained therein not misleading in light of the circumstances in which made; provided, however, that (i) no representation or warranty is made with respect to any projections or other forward-looking statement provided by or on behalf of the Seller, except as to factual information provided which formed the basis for preparing such projections and that such projections were made or prepared in good faith and based upon reasonable assumptions, it being understood that no assurance can be given that the projections will be realized, and that actual results may differ and such differences may be material, (ii) to the extent that any reports or other submittals are based on information provided by a Person other than Seller, to the knowledge of Seller, such information was not false or misleading in any material respect, and (iii) any update or re-submittal of a report or other submittal shall be deemed to supersede any previously submitted report of other submittal covering the same subject matter and any differences between reports and other submittal and updated or re-submitted reports or other submittals shall

not constitute a breach of this representation so long as the previous submittal did not have a material adverse effect on Buyer.

(l) No Default. No Default or Event of Default has occurred and is continuing and no Default or Event of Default shall occur as a result of the performance by Seller of its obligations under this Agreement.

(m) Site Control. As of the Effective Date, Seller (i) holds a federal lease issued on a competitive basis after January 1, 2012 for an offshore wind energy generation site located on the Outer Continental Shelf and for which no turbine is located within ten miles of any inhabited area; ~~and (ii) has either (a) a valid lease, or option to lease, for marine terminal facilities necessary for staging and deployment of major components to the Facility site, and (iii) has acquired, or reasonably expects to have prior to the time needed,~~ all other real property rights to construct and operate the Facility, ~~(to the extent it is Seller's responsibility to do so), to interconnect the Facility to the Interconnecting Utility, to construct the Network Upgrades (to the extent it is Seller's responsibility to do so) and to perform Seller's obligations under this Agreement or (ii) has an irrevocable option to acquire such other real property rights and the only condition upon Seller's exercise of such option to acquire such real property rights is the payment of an amount that represents the fair market value of such real property rights.~~

~~(n) — Forward Capacity Market Participation. Seller shall take (i) all necessary and appropriate actions to qualify and participate in every FCM auction applicable to the Services Term; and (ii) commercially reasonable actions to be selected and compensated in every FCM auction applicable to the Services Term, in each case with a Seasonal Claimed Capacity of not less than [] MW. Subject to Good Utility Practice, Seller shall operate the Facility in a manner to maximize the Capacity Supply Obligation of the Facility. *[Provision included to the extent the proposal contemplates an FCM commitment]*~~

7.3 Continuing Nature of Representations and Warranties. The representations and warranties set forth in this Section are made as of the Effective Date and deemed made continually throughout the Term, subject to the removal of the references to the Regulatory Approval and Permits as and when the Regulatory Approval and Permits are obtained, ~~and~~ except to the extent that such representation and warranty states that it is permitted or required to be made only as of a specific date. If at any time during the Term, a Party has knowledge of any event or information which causes any of the representations and warranties in this Article 7 to be untrue or misleading, such Party shall provide the other Party with prompt written notice of the event or information, the representations and warranties affected, and the corrective action such Party shall take. The notice required pursuant to this Section shall be given as soon as practicable after the occurrence of each such event.

8. REGULATORY APPROVAL

8.1 Receipt of Regulatory Approval. The obligations of the Parties to perform this Agreement, other than the Parties' obligations under Section ~~6-13.7~~, Section ~~8-26.1~~, and Section 12, are conditioned upon and shall not become effective or binding until the receipt of the Regulatory Approval. Buyer shall notify Seller within five (5) Business Days after receipt of the Regulatory Approval or receipt of an order of the MDPU ~~regarding this Agreement that is not the~~

MDPU Order. [REDACTED]
 [REDACTED]
 [REDACTED]
 [REDACTED]

~~8.2 Related Transmission Approvals. The obligation of the Parties to perform this Agreement is further conditioned upon the receipt of any Related Transmission Approvals on or prior to the date such Related Transmission Approvals are required under Applicable Law.~~

9. BREACHES; REMEDIES

9.1 Events of Default by Either Party. It shall constitute an event of default ("**Event of Default**") by either Party hereunder if:

(a) Representation or Warranty. Any breach of any representation or warranty of such Party set forth herein, or in filings or reports made pursuant to this Agreement occurs, where such breach is not fully cured and corrected within thirty (30) days after the Non-Defaulting Party has provided written notice to the Defaulting Party; ~~or provided, however, with respect to the representations and warranties set forth in Sections 7.1(b)(iii), (e), (f), (g), and (h) and Sections 7.2(b)(iii), (f), (g), (h), (i), (j), (k), and (l), such period shall be extended for an additional period of sixty (60) days if, despite using commercially reasonable efforts, the Defaulting Party is unable to cure within the initial thirty (30) day period so long as such cure is diligently pursued by the Defaulting Party until such Default has been corrected and such extended cure period will not impair the ability of the Seller to Deliver the Products or otherwise does not have a material adverse effect on Buyer or the benefits Buyer expects to receive under this Agreement, but in any event shall be cured within ninety (90) days of the notice from the Non-Defaulting Party; or~~

(b) Payment Obligations. Any undisputed payment due and payable hereunder is not made on the date due, and such failure continues for more than ten (10) Business Days after notice thereof is given by the Non-Defaulting Party to the Defaulting Party; or

- (c) Other Covenants. Other than:
- (i) a Delivery Failure not exceeding ten (10) continuous days;
 - (ii) failure of the Facility to achieve the Commercial Operation Date by the Guaranteed Commercial Operation Date;
 - (iii) a failure to maintain the RPS eligibility requirements set forth in Section 4.7(b) due to a change in Law,
 - (iv) a Rejected Purchase, or
 - (v) an Event of Default described in Section 9.1(a), 9.1(b), 9.1(d), 9.1(e), 9.1(f) or 9.2,

such Party fails to perform, observe or otherwise to comply with any obligation hereunder and such failure continues for more than thirty (30) days after notice thereof is given by the Non-Defaulting Party to the Defaulting Party; provided, however, such period shall be extended for an additional period of up to thirty (30) days if, despite using commercially reasonable efforts, the Defaulting Party is unable to cure within the initial thirty (30) day period so long as such cure is diligently pursued by the Defaulting Party until such Default had been corrected, but in any event shall be cured within sixty (60) days of the notice from the Non-Defaulting Party; or

(d) Bankruptcy. Such Party (i) is adjudged bankrupt or files a petition in voluntary bankruptcy under any provision of any bankruptcy law or consents to the filing of any bankruptcy or reorganization petition against such Party under any such law, or (without limiting the generality of the foregoing) files a petition to reorganize pursuant to 11 U.S.C. § 101 or any similar statute applicable to such Party, as now or hereinafter in effect, (ii) makes an assignment for the benefit of creditors, or admits in writing an inability to pay its debts generally as they become due, or consents to the appointment of a receiver or liquidator or trustee or assignee in bankruptcy or insolvency of such Party, or (iii) is subject to an order of a court of competent jurisdiction appointing a receiver or liquidator or custodian or trustee of such Party or of a major part of such Party's property, which is not dismissed within sixty (60) days; or

(e) Permit Compliance. ~~Such Party fails to obtain and maintain or cause to be obtained and maintained in full force and effect any Permit (other than the Regulatory Approval) necessary for such Party to perform its obligations under this Agreement. Such Party has a Permit Failure, where such Permit Failure is not fully cured and corrected within thirty (30) days after the Non-Defaulting Party has provided written notice to the Defaulting Party; provided, however, that if a Party has more than three (3) Permit Failures during the Term, then such Defaulting Party shall no longer have the benefit of any cure period; or~~

(f) Assignment. ~~The assignment of this Agreement by a Party except as permitted in accordance with Article 14.~~

Formatted: Underline

9.2 Events of Default by Seller. In addition to the Events of Default described in Section 9.1, each of the following shall constitute an Event of Default by Seller hereunder if:

(a) Taking of Facility Assets. ~~Any Other than with respect to a foreclosure on any of the assets of Seller associated with a Financing, any~~ asset of Seller that is ~~material~~ ~~required for~~ the construction, operation or maintenance of the Facility or the performance of its obligations hereunder is taken upon execution or by other process of law directed against Seller, or any such asset is taken upon or subject to any attachment by any creditor of or claimant against Seller and such attachment is not disposed of within sixty (60) days after such attachment is levied; or

(b) Failure to Maintain Credit Support. The failure of Seller to provide, maintain and/or replenish the Development Period Security or the Operating Period Security as required pursuant to Article 6 of this Agreement; and such failure continues for more than five (5) Business Days after Buyer has provided written notice thereof to Seller; For the avoidance of doubt, it shall be deemed an Event of Default if Seller provides Credit Support in the form of a ~~letter~~ Letter of ~~credit~~ Credit and, with respect to an outstanding ~~letter~~ Letter of ~~credit~~ Credit, one of

the following events occurs with respect to the issuer of such ~~letter~~Letter of ~~credit~~Credit: (i) such issuer shall fail to be a Qualified Bank; (ii) such issuer shall fail to comply with or perform its obligations under such ~~letter~~Letter of ~~credit~~Credit; or (iii) such issuer shall disaffirm, disclaim, repudiate or reject, in whole or in part, or challenge the validity of, such ~~letter~~Letter of ~~credit~~Credit, and such failure, disaffirmation, disclamation, repudiation or rejection continues for more than five (5) Business Days after Buyer has provided written notice thereof to Seller; ~~(a "Letter of Credit Default"). Notwithstanding the foregoing, no Event of Default shall arise under this Section 9.2(b) if a Letter of Credit Default has occurred, the applicable Letter of Credit remains in effect, and Buyer has not attempted to draw on such effective Letter of Credit to satisfy Seller's Credit Support obligations with Cash, it being understood that Buyer otherwise has no obligation to draw on such Letter of Credit prior to its expiration or termination;~~ or

(c) Energy Output. The failure of the Facility to produce Energy for twelve (12) consecutive months during the Services Term, ~~except to the extent excused by (i) a Force Majeure, (ii) a Catastrophic Failure resulting in the Facility not producing Energy for up to the Catastrophic Failure Period, or (iii) negative LMPs at the Delivery Point (as described in Section 4.2(a)) for the entire twelve (12) month period;~~ or

Formatted: Font: Not Bold

~~(d) Failure to Satisfy ISO-NE Obligations. The failure of Seller to satisfy, or cause to be satisfied (other than by Buyer), any material obligation under the ISO-NE Rules or ISO-NE Practices or any other obligation with respect to ISO-NE and such failure has an adverse effect on the Facility or Seller's ability to perform its obligations under this Agreement or on Buyer or Buyer's rights or ability to receive the benefits under this Agreement; provided, however, if Seller's failure to satisfy any obligation under the ISO-NE Rules or ISO-NE Practices does not have an adverse effect on Buyer or Buyer's ability to receive the benefits under this Agreement, Seller shall have the opportunity to cure such failure within thirty (30) days of its occurrence;~~ or

(d) Reserved.

(e) Failure to Meet Critical Milestones. ~~The~~Subject to the terms and provisions of Section 3.2, the failure of Seller to satisfy any Critical Milestone by the date set forth therefor in Section 3.1(a), as the same may be extended in accordance with ~~Section~~Sections 3.1(c); 3.1(d), 3.1(e) and 10.1; or

(f) Abandonment. On or after the Commercial Operation Date, the permanent relinquishment by Seller of all of its possession and control of the Facility, other than a transfer permitted under this Agreement ~~or to the extent caused by a Force Majeure or an Event of Default by Buyer;~~ or

(g) Sale or Transfer. ~~Assignment.~~ ~~The assignment of this Agreement by Seller,~~ or Seller's sale or transfer of its interest (or any part thereof) in the Facility, except as permitted in accordance with Article 14; or

Formatted: Underline

(h) Recurring Delivery Failure. A Delivery Failure of ten (10) continuous days or more; or

(i) Failure to Provide Status Reports. A failure to provide timely, accurate and complete ~~status~~progress reports in accordance with Section 3.3(d) of this Agreement, and such failure continues for more than ~~five (5)~~ten (10) days after notice thereof is given by the Buyer; or

(j) Failure to Maintain RPS Eligibility. A failure to maintain RPS eligibility ~~requirements~~as set forth in Section 4.7(b).

9.3 Remedies.

(a) Suspension of Performance and Remedies at Law. Upon the occurrence and during the continuance of an Event of Default, the Non-Defaulting Party shall have the right, but not the obligation, to (i) withhold any payments due the Defaulting Party under this Agreement, (ii) suspend its performance hereunder, and (iii) exercise such other remedies as provided for in this Agreement including, without limitation, the termination right set forth in Section 9.3(b), and, to the extent not inconsistent with the terms of this Agreement, such remedies available at law and in equity. In addition to the foregoing, except for breaches for which an express remedy or measure of damages is provided herein, the Non-Defaulting Party shall retain its right of specific performance to enforce the Defaulting Party's obligations under this Agreement.

(b) Termination and Termination Payment. Upon the occurrence of an Event of Default, a Non-Defaulting Party may terminate this Agreement at its sole discretion by providing written notice of such termination to the Defaulting Party. If the Non-Defaulting Party terminates this Agreement, it shall be entitled to calculate and receive as its sole remedy for such Event of Default a "Termination Payment" as follows:

(i) Termination by Buyer Prior to Commercial Operation Date. If Buyer terminates this Agreement because of an Event of Default by Seller occurring prior to the Commercial Operation Date, the Termination Payment due to Buyer shall be equal to the sum of (x) all Delay Damages due and owing by Seller through the date of such termination plus (y) the full amount of the Development Period Security required to be provided to Buyer by Seller.

(ii) Termination by Seller Prior to Commercial Operation Date. If Seller terminates this Agreement because of an Event of Default by Buyer prior to the Commercial Operation Date, ~~Seller shall only receive a Termination Payment if the Commercial Operation Date either occurs on or before the Guaranteed Commercial Operation Date or would have occurred by such date but for the Event of Default by Buyer giving rise to the termination of this Agreement. In such case, then~~ (x) if Seller terminates this Agreement because ~~of an Event of Default by Buyer~~ prior to the earlier of (1) Financial Closing Date, and (2) the date that Seller issues a full notice to proceed with construction of the Facility, the Termination Payment due to Seller shall be equal to the lesser of: (i) Buyer's Percentage

Entitlement to Seller's out-of-pocket expenses incurred in connection with the development and construction of the Facility prior to such termination and for which Seller has provided adequate documentation to enable Buyer to verify the expense claimed, or (ii) the Termination Payment due to Seller as calculated according to the methodology in Section 9.3(b)(iv), as if the Commercial Operation Date had occurred prior to the date of the termination by Seller; and (y) ~~if Seller terminates this Agreement because of an Event of Default by Buyer~~ on or after the earlier of (1) Financial Closing Date, and (2) the date that Seller issues a full notice to proceed with construction of the Facility, the Termination Payment due to Seller shall be calculated according to the methodology in Section 9.3(b)(iv), as if the Commercial Operation Date had occurred prior to the date of the termination by Seller.

- (iii) *Termination by Buyer On or After Commercial Operation Date.* If Buyer terminates this Agreement because of an Event of Default by Seller occurring on or after the Commercial Operation Date, the Termination Payment due to Buyer shall be equal to the greater of: (i) the security required to be provided in accordance with Article 6, or (ii) the amount, if positive, calculated according to the following formula: (x) the present value, discounted at a rate equal to the ~~prime~~ten (10) year U.S. Treasury note rate ~~specified in the "Money & Investing" section of The Wall Street Journal determined as of the date of the notice of default,~~ plus ~~300~~200 basis points, for each month ~~of the remaining in the Services Term,~~ (the "Remaining Term"), of (A) the amount, if any, by which the forward market price of Energy and Renewable Energy Credits, as determined by the average of the quotes of at least two nationally recognized energy consulting firms or brokers chosen by Buyer, for Replacement Energy and Replacement RECs, exceeds the applicable Price that would have been paid pursuant to Exhibit D of this Agreement, multiplied by (B) Buyer's Percentage Entitlement of the projected Energy output of the Facility as determined by a recognized third party expert selected by Buyer, using a probability of exceedance basis of 50%; plus, (y) any ~~costs incurred or to be incurred by Buyer in connection with the Related Transmission Facilities for the Energy not delivered as a result of such Termination in excess of such costs for Replacement Energy,~~ plus (z) ~~any costs and losses incurred by Buyer as a result of other transaction and other out-of-pocket costs incurred by Buyer that Buyer would not have incurred but for~~ the Event of Default and termination of the Agreement.

All such amounts shall be determined by Buyer in good faith and in a commercially reasonable manner, and Buyer shall provide

Seller with a reasonably detailed calculation of the Termination Payment due under this Section 9.3(b)(iii).

- (iv) *Termination by Seller On or After Commercial Operation Date.* If Seller terminates this Agreement because of an Event of Default by Buyer occurring on or after the Commercial Operation Date, the Termination Payment due to Seller shall be equal to the amount, if positive, calculated according to the following formula: (x) the present value, discounted at a rate equal to the ~~prime~~ten (10) year U.S. Treasury note rate ~~specified in the “Money & Investing” section of The Wall Street Journal determined as of the date of the notice of default,~~ plus ~~300~~200 basis points, for each month ~~remaining in of~~ the Services Remaining Term, of (i) the amount, if any, by which the applicable Price that would have been paid pursuant to Exhibit D of this Agreement, exceeds the forward market price of Energy and Renewable Energy Credits as determined by the average of the quotes of at least two nationally recognized energy consulting firms or brokers chosen by Seller, for Replacement Energy and Replacement RECs, multiplied by (ii) Buyer’s Percentage Entitlement to the projected Energy output of the Facility as determined by a recognized third party expert selected by Seller using a probability of exceedance basis of 50%; plus, (y) any other transaction and other out-of-pocket costs and losses incurred by Seller ~~as a result of that Seller would not have incurred but for~~ the Event of Default and termination of the Agreement.

All such amounts shall be determined by Seller in good faith and in a commercially reasonable manner, and Seller shall provide Buyer with a reasonably detailed calculation of the Termination Payment due under this Section 9.3(b)(iv).

- (v) *Acceptability of Liquidated Damages.* Each Party agrees and acknowledges that (i) the damages and losses (including without limitation the loss of environmental, reliability and economic benefits contemplated under this Agreement) that the Parties would incur due to an Event of Default would be difficult or impossible to predict with certainty, and (ii) it is impractical and difficult to assess actual damages in the circumstances stated, and therefore the Termination Payment as agreed to by the Parties and set forth herein is a fair and reasonable calculation of such damages.
- (vi) *Payment of Termination Payment.* For the avoidance of doubt, the Defaulting Party shall not be obligated to pay any termination damages if the amount of the Termination Payment calculated pursuant to this Section 9.3 is equal to or less than zero (0). The Defaulting Party shall make the Termination Payment within ten

(10) Business Days after such notice is effective, regardless of whether the Termination Payment calculation is disputed. If the Defaulting Party disputes the Non-Defaulting Party's calculation of the Termination Payment, in whole or in part, the Defaulting Party shall within ten (10) Business Days of receipt of the calculation of the Termination Payment, provide to the Non-Defaulting Party a detailed written explanation of the basis for such dispute. If the Parties are unable to resolve the dispute within thirty (30) days, Article 11 shall apply.

(c) Set-off. ~~The~~ Subject to Section 9.3(b)(vi), the Non-Defaulting Party shall be entitled, at its option and in its discretion, to withhold and set off any amounts owed by the Non-Defaulting Party to the Defaulting Party against any payments and any other amounts owed by the Defaulting Party to the Non-Defaulting Party, including any Termination Payment payable as a result of any early termination of this Agreement.

(d) Notice to Lenders. Seller shall provide Buyer with a notice identifying a single Lender (if any) and Tax Equity Investor to whom default notices are to be issued. Buyer shall provide a copy of the notice of any default of Seller under this Article 9 to that Lender, and Buyer shall afford such Lender the same opportunities to cure Events of Default under this Agreement as are provided to Seller hereunder.

(e) Limitation of Remedies, Liability and Damages. EXCEPT AS EXPRESSLY SET FORTH HEREIN, THERE IS NO WARRANTY OF MERCHANTABILITY OR FITNESS FOR A PARTICULAR PURPOSE, AND ANY AND ALL IMPLIED WARRANTIES ARE DISCLAIMED. THE PARTIES CONFIRM THAT THE EXPRESS REMEDIES AND MEASURES OF DAMAGES PROVIDED IN THIS AGREEMENT SATISFY THE ESSENTIAL PURPOSES HEREOF. FOR BREACH OF ANY PROVISION FOR WHICH AN EXPRESS REMEDY OR MEASURE OF DAMAGES IS PROVIDED, SUCH EXPRESS REMEDY OR MEASURE OF DAMAGES SHALL BE THE SOLE AND EXCLUSIVE REMEDY, THE OBLIGOR'S LIABILITY SHALL BE LIMITED AS SET FORTH IN ~~SUCH PROVISION~~ THIS AGREEMENT AND ALL OTHER REMEDIES OR DAMAGES AT LAW OR IN EQUITY ARE WAIVED. IF NO REMEDY OR MEASURE OF DAMAGES IS EXPRESSLY PROVIDED HEREIN, THE OBLIGOR'S LIABILITY SHALL BE LIMITED TO DIRECT ACTUAL DAMAGES ONLY, SUCH DIRECT ACTUAL DAMAGES SHALL BE THE SOLE AND EXCLUSIVE REMEDY, AND ALL OTHER REMEDIES OR DAMAGES AT LAW OR IN EQUITY ARE WAIVED. UNLESS EXPRESSLY HEREIN PROVIDED, NEITHER PARTY SHALL BE LIABLE FOR CONSEQUENTIAL, INCIDENTAL, PUNITIVE, EXEMPLARY OR INDIRECT DAMAGES, LOST PROFITS OR OTHER BUSINESS INTERRUPTION DAMAGES, BY STATUTE, IN TORT OR CONTRACT, UNDER ANY INDEMNITY PROVISION OR OTHERWISE. TO THE EXTENT ANY DAMAGES REQUIRED TO BE PAID HEREUNDER ARE LIQUIDATED, THE PARTIES ACKNOWLEDGE THAT THE DAMAGES ARE DIFFICULT OR IMPOSSIBLE TO DETERMINE, OR OTHERWISE OBTAINING AN ADEQUATE REMEDY IS INCONVENIENT AND THE DAMAGES CALCULATED HEREUNDER CONSTITUTE A REASONABLE APPROXIMATION OF THE HARM OR LOSS.

10. FORCE MAJEURE

10.1 Force Majeure.

(a) The term “**Force Majeure**” means an unusual, unexpected and significant event: (i) that was not within the control of the Party claiming its occurrence; (ii) that could not have been prevented or avoided by such Party through the exercise of reasonable diligence; and (iii) that directly prohibits or prevents such Party from performing its obligations under this Agreement. Under no circumstances shall Force Majeure include (v) any full or partial curtailment in the electric output of the Facility that is caused by or arises from a mechanical or equipment breakdown or other mishap or events or conditions attributable to normal wear and tear or flaws, unless such curtailment or mishap ~~is caused by one of the following: acts of God such as floods, hurricanes or tornados; sabotage; terrorism; or war~~would otherwise qualify as a **Force Majeure**, (w) any occurrence or event that merely increases the costs or causes an economic hardship to a Party, (x) any occurrence or event that was caused by or contributed to by the Party claiming the Force Majeure, (y) Seller’s ability to sell the Products at a price greater than that set out in this Agreement, or (z) Buyer’s ability to procure the Products at a price lower than that set out in this Agreement. In addition, a delay or inability to perform attributable to a Party’s lack of preparation, a Party’s failure to timely obtain and maintain all necessary Permits (excepting the Regulatory Approval) or qualifications, any delay or failure in satisfying the Critical Milestone obligations specified in Section 3.1(a)(i) (Permits) or Section 3.1(a)(iii) (Financing), a failure to satisfy contractual conditions or commitments, or lack of or deficiency in funding or other resources shall each not constitute a Force Majeure or be the basis for a claim of Force Majeure. Neither Party may raise a claim of Force Majeure based in whole or in part on curtailment by a Transmission Provider unless (i) such Party has contracted for firm transmission with a Transmission Provider for the Products to be delivered to or received at the Delivery Point and (ii) such curtailment is due to “force majeure” or “uncontrollable force” or a similar term as defined under the Transmission Provider’s tariff; provided, however, that existence of the foregoing factors shall not be sufficient to conclusively or presumptively prove the existence of a Force Majeure absent a showing of other facts and circumstances which in the aggregate with such factors establish that a Force Majeure as defined herein has occurred.

(b) Subject to Section 3.1(d), if either Party is unable, wholly or in part, by Force Majeure to perform obligations under this Agreement, such performance shall be excused and suspended so long as the circumstances that give rise to such inability exist or would exist if the Party claiming the Force Majeure used commercially reasonable efforts to cure such circumstances, but for no longer period. The Party whose performance is affected shall give prompt notice thereof; such notice may be given orally or in writing but, if given orally, it shall be promptly confirmed in writing, providing details regarding the nature, extent and expected duration of the Force Majeure, its anticipated effect on the ability of such Party to perform obligations under this Agreement, and the estimated duration of any interruption in service or other adverse effects resulting from such Force Majeure, and shall be updated or supplemented to keep the other Party advised of the effect and remedial measures being undertaken to overcome the Force Majeure. Such inability shall be promptly corrected to the extent it may be corrected through the exercise of due diligence. Neither ~~party~~Party shall be liable for any losses or damages arising out of a suspension of performance that occurs because of Force Majeure.

(c) Notwithstanding the foregoing, if the Force Majeure prevents full or partial performance under this Agreement for a period of ~~twelve (12)~~twenty-four (24) months or more, the Party whose performance is not prevented by Force Majeure shall have the right to terminate this Agreement upon written notice to the other Party and without further recourse. In no event will any delay or failure of performance caused by any conditions or events of Force Majeure extend this Agreement beyond its stated Term.

11. DISPUTE RESOLUTION

11.1 Dispute Resolution. In the event of any dispute, controversy or claim between the Parties arising out of or relating to this Agreement (collectively, a “**Dispute**”), in addition to any other remedies provided hereunder, the Parties shall attempt to resolve such Dispute through consultations between the Parties. If the Dispute has not been resolved within fifteen (15) Business Days after such consultations between the Parties, then either Party may seek to resolve such Dispute in the courts of the Commonwealth of Massachusetts; provided, however, if the Dispute is subject to FERC’s jurisdiction over wholesale power contracts, then either Party may elect to proceed with the mediation through FERC’s Dispute Resolution Service in lieu of litigation; provided, however, that if one Party fails to participate in the negotiations as provided in this Section 11.1, the other Party can initiate litigation or mediation through FERC’s Dispute Resolution Service prior to the expiration of the ~~thirty (30)~~fifteen (15) Business Days. Unless otherwise agreed, the Parties will select a mediator from the FERC panel. The Parties may, by written agreement signed by both Parties, alter any time deadline, location(s) for meeting(s), or procedure outlined herein or in FERC’s rules for mediation. The procedure specified herein shall be the sole and exclusive procedure for the resolution of Disputes. To the fullest extent permitted by law, any mediation proceeding and any settlement shall be maintained in confidence by the Parties.

11.2 Allocation of Dispute Costs. The fees and expenses associated with mediation shall be divided equally between the Parties, and each Party shall be responsible for its own legal fees, including but not limited to attorney fees, associated with any Dispute.

11.3 Consent to Jurisdiction. Subject to Section 11.1, the Parties agree to the exclusive jurisdiction of the state and federal courts located in the Commonwealth of Massachusetts for any legal proceedings that may be brought by a Party arising out of or in connection with any Dispute.

11.4 Waiver of Jury Trial and Inconvenient Forum Claim. EACH PARTY HEREBY WAIVES TO THE FULLEST EXTENT PERMITTED BY LAW ANY RIGHT IT MAY HAVE TO A TRIAL BY JURY IN RESPECT OF ANY SUIT, ACTION OR PROCEEDING ARISING OUT OF, RESULTING FROM OR IN ANY WAY RELATING TO THIS AGREEMENT. BOTH PARTIES IRREVOCABLY WAIVE, TO THE FULLEST EXTENT PERMITTED BY LAW, ANY OBJECTION THAT THEY MAY NOW OR HEREAFTER HAVE TO THE LAYING OF VENUE AS SET FORTH IN THIS ARTICLE 11 AND ANY CLAIM THAT ANY SUCH PROCEEDING HAS BEEN BROUGHT IN ANY INCONVENIENT FORUM.

12. CONFIDENTIALITY

12.1 Nondisclosure. For a period of two (2) years from the expiration or earlier termination of this Agreement. Buyer and Seller each ~~agrees~~agree not to disclose to any Person and to keep confidential, and to cause and instruct its Affiliates, officers, directors, employees, partners and representatives not to disclose to any Person and to keep confidential, any non-public information relating to the terms and provisions of this Agreement, and any information relating to the Products to be supplied by Seller hereunder, and such other non-public information that is designated as “Confidential.” Notwithstanding the foregoing, any such information may be disclosed:

(a) to the extent Buyer determines it is appropriate in connection with efforts to obtain or maintain the Regulatory Approval or to seek rate recovery for amounts expended by Buyer under this Agreement

(b) as required by applicable laws, regulations, filing requirements, rules or orders or by any subpoena or similar legal process of any Governmental Entity so long as the disclosing Party gives the non-disclosing Party written notice at least three (3) Business Days prior to such disclosure, if practicable;

(c) to the Affiliates of either Party and to the consultants, attorneys, auditors, financial advisors, lenders ~~or investors~~, potential lenders, potential investors, and their advisors of either Party or their Affiliates or investment funds, investment committees, limited partners, or successor funds, in each case, of an Indirect Parent Entity or a fund managed by an Indirect Parent Entity, but solely to the extent they have a need to know that information;

(d) in order to comply with any rule or regulation of ISO-NE, other system operators, any stock exchange or similar Person or for financial disclosure purposes;

(e) to the extent the non-disclosing Party shall have consented in writing prior to any such disclosure; and

(f) to the extent that the information was previously made publicly available other than as a result of a breach of this Section 12.1;

provided, however, in each case, that the Party seeking such disclosure shall, to the extent practicable, use commercially reasonable efforts to prevent or limit the disclosure. The Parties shall be entitled to all remedies available at law or in equity to enforce or seek relief in connection with this Section 12.1.

12.2 Public Statements. No public statement, press release or other voluntary publication regarding this Agreement or the transactions to be made hereunder shall be made or issued without the prior consent of the other Party.

13. INDEMNIFICATION

13.1 Indemnification Obligations. Seller shall indemnify, defend and hold Buyer and its partners, shareholders, directors, officers, employees and agents (including, but not limited to,

Affiliates and contractors and their employees), harmless from and against (without duplication) all liabilities, damages, losses, penalties, claims, demands, suits and proceedings of any nature whatsoever (“Losses”) due to or instituted by a third party arising from or related to ~~Seller’s execution, delivery or performance of this Agreement,~~ or Seller’s negligence, gross negligence, or willful misconduct, or Seller’s failure to satisfy any obligation or liability under this Agreement, or Seller’s failure to satisfy any regulatory requirement or commitment associated with this Agreement-

13.2 Notice of Claims; Procedure. Buyer shall give reasonable notice to Seller of any claim or notice of the commencement of any action, administrative or legal proceeding or investigation as to which indemnification under this Article 13 may apply or promptly after Buyer has actual knowledge of any other Loss that would result in a claim for indemnification. Buyer shall reasonably cooperate with Seller in the defense of any such claim. Seller will use counsel reasonably satisfactory to Buyer to defend any such claim and shall control the defense of any such claim. Buyer may participate in the defense of any such claim at its own expense. Seller may not agree to any settlement or compromise of any claim without Buyer’s prior written consent (which consent may not be unreasonably withheld) that is not an unconditional release of Buyer from any and all liabilities upon the payment of money that will be paid by the Seller.

~~13.2~~13.3 Failure to Defend. If Seller fails to assume the defense of a claim meriting indemnification, Buyer may at the expense of Seller contest, settle or pay such claim, and shall promptly reimburse Buyer for all costs incurred by Buyer associated therewith.

13.4 Contributory Negligence. If the joint, concurring, comparative or contributory fault or negligence of the Parties gives rise to the Losses for which the Parties are entitled to indemnification under this Article 13, then any Losses shall be allocated between the Parties in proportion to their respective degrees of fault or negligence contributing for such Losses.

13.5 Survival; Limitations. The indemnity obligations and rights of the Parties set forth in this Article 13 will survive the termination of this Agreement or expiration of the applicable statute of limitations to which an indemnification claim could relate.

14. ASSIGNMENT AND CHANGE OF CONTROL

14.1 Prohibition on Assignments. Except as permitted under this Article 14, this Agreement (and any portion thereof) may not be assigned by either Party without the prior written consent of the other Party, which consent may not be unreasonably withheld, conditioned or delayed. The Party requesting the other Party’s consent to an assignment of this Agreement will reimburse such other Party for ~~all~~the documented, reasonable “out of pocket” costs and expenses such other Party incurs in connection with that consent, without regard to whether such consent is provided. When assignable, this Agreement shall be binding upon, shall inure to the benefit of, and may be performed by, the successors and assignees of the Parties, except that no assignment, pledge or other transfer of this Agreement by either Party shall operate to release the assignor, pledgor, or transferor from any of its obligations under this Agreement (and shall not impair any Credit Support given by Seller hereunder) unless the other Party (or its successors or assigns) consents in writing to the assignment, pledge or other transfer and expressly releases the assignor, pledgor, or transferor from its obligations thereunder.

14.2 Permitted Assignment by Seller. Buyer's consent shall not be required for Seller to ~~either (a) pledge or assign the Facility, this Agreement, or the accounts, revenues, under, or proceeds from~~ this Agreement to any Lender as security for any Financing of the Facility; ~~provided, however, or (b) assign the Facility and this Agreement to an Affiliate if Seller requests Buyer's the then-current Development Period Security or Operational Period Security, as applicable, remains in place.~~ Upon Seller's reasonable request, Buyer shall (i) execute a consent to ~~such an assignment;~~ ~~(i) Buyer shall provide that consent subject to Buyer's execution of a consent to assignment in a~~ associated with a Financing in a commercially reasonable form acceptable to Buyer and Seller, and (ii) provide estoppels associated with a Financing in a commercially reasonable form acceptable to Buyer and Seller. Seller will reimburse Buyer for all "out of pocket" costs and expenses Buyer incurs in connection with ~~that any requested~~ consent to assignment or estoppel, without regarding to whether such consent is provided.

14.3 Change in Control over Seller. Buyer's consent shall be required for any change in Control over Seller, which consent shall not be unreasonably withheld, conditioned or delayed and shall be provided if Buyer reasonably determines that such change in Control does not have a material adverse effect on Seller's creditworthiness or Seller's ability to perform its obligations under this Agreement; ~~provided, however, the Parties agree that Buyer's consent shall not be required in connection with the following:~~ (i) any Tax Equity Transaction or any exercise of removal rights by a Tax Equity Investor in connection with a Tax Equity Transaction resulting in such Tax Equity Investor having Control over Seller; (ii) any assignment of all or a portion of the equity interests in Seller or in any Affiliate of Seller to any Lender as security for any Financing of the Facility, and any foreclosure on such equity interests in connection with such Financing; (iii) any assignment by the owners of Seller as of the Effective Date of less than fifty percent (50%) of such owner's equity interests in Seller whereby such owner does not grant Control to such assignee, (iv) any merger or consolidation of any Indirect Parent Entity with or into another Person or any exchange of all of the common stock or other equity interest of any Indirect Parent Entity or any Indirect Parent Entity's parent for cash, securities or other property or any acquisition, reorganization, or other similar corporate transaction involving all or substantially all of the common stock or other equity interests in, or assets of, any Indirect Parent Entity; (v) any change in the relative ownership percentages of equity interest in Seller by the owners thereof as of the Effective Date; or (vi) a direct or indirect assignment of all or a portion of the equity interests in Seller to an Affiliate; provided, further, that the Credit Support required under this Agreement shall remain in place or Buyer shall receive substitute Credit Support meeting the requirements of this Agreement.

14.4 Permitted Assignment by Buyer. Buyer shall have the right to assign this Agreement without consent of Seller (a) in connection with any merger or consolidation of the Buyer with or into another Person or any exchange of all of the common stock or other equity interests of Buyer or Buyer's parent for cash, securities or other property or any acquisition, reorganization, or other similar corporate transaction involving all or substantially all of the common stock or other equity interests in, or assets of, Buyer, or (b) to any substitute purchaser of the Products so long as (i) in the case of ~~either~~ clause (a) ~~or clause (b)~~ of this Section 14.4, either (1) the proposed assignee's credit rating for unsecured, senior long-term debt obligations is at least either BBB- from S&P or Baa3 from Moody's, or (2) the proposed assignee's credit rating is equal to or better than that of Buyer at the time of the proposed assignment, or (3) such assignment, or in the case of clause (a) above the transaction associated with such assignment,

has been approved by the MDPU or the appropriate ~~Government~~Governmental Entity- with jurisdiction over such transaction, or (ii) in the case of clause (b) of this Section 14.4, the proposed assignee has a credit rating that is at least Investment Grade and is regulated by the MDPU or another Governmental Agency that approves the recovery in rates of amounts expended under this Agreement.

14.5 Prohibited Assignments. Any purported assignment of this Agreement not in compliance with the provisions of this Article 14 shall be null and void.

15. TITLE; RISK OF LOSS

Title to and risk of loss related to Buyer’s Percentage Entitlement of the Energy shall transfer from Seller to Buyer at the Delivery Point. Title and risk of loss related to Buyer’s Percentage Entitlement of the RECs shall transfer to Buyer ~~when the same are credited to Buyer’s GIS account(s) or the GIS account(s) designated by Buyer to Seller in writing~~ ~~on the Effective Date~~ ~~[Alternative REC Transfer Language]~~. Seller warrants that it shall deliver to Buyer the Products free and clear of all liens and claims therein or thereto by any Person.

16. AUDIT

16.1 Audit. Each Party shall have the right, upon reasonable advance notice, and at its sole expense (unless the other Party has defaulted under this Agreement, in which case the Defaulting Party shall bear the expense) and during normal working hours, to examine the records of the other Party to the extent reasonably necessary to verify the accuracy of any statement, charge or computation made pursuant to this Agreement. If requested, a Party shall provide to the other Party additional information documenting the quantities of Products delivered or provided hereunder. If any such examination reveals any overcharge or undercharge, the necessary adjustments in such statement and the payments thereof shall be made promptly and shall include interest at the Late Payment Rate from the date the overpayment or underpayment was made until credited or paid.

16.2 Access to Financial Information. Seller shall provide to Buyer within fifteen (15) days of receipt of Buyer’s written request financial information and statements applicable to Seller as well as access to financial personnel, so that Buyer may address any inquiries from a Governmental Entity relating to Seller’s financial resources.

17. NOTICES

Any notice or communication given pursuant hereto shall be in writing and (1) delivered personally (personally delivered notices shall be deemed given upon written acknowledgment of receipt after delivery to the address specified or upon refusal of receipt); or (2) mailed by registered or certified mail, postage prepaid (mailed notices shall be deemed given on the actual date of delivery, as set forth in the return receipt, or upon refusal of receipt); or (3) delivered by fax or electronic mail (notices sent by fax or electronic mail shall be deemed given upon confirmation of delivery); or (4) by reputable overnight courier; in each case addressed as follows or to such other addresses as may hereafter be designated by either Party to the other in writing:

If to Buyer: ~~[]~~James G. Daly, Vice President – Energy Supply
Eversource Energy
247 Station Drive/ SE250
Westwood, MA 02090

Formatted: Spanish (United States)
Formatted: Normal, Indent: Left: 0.5", Hanging: 1.25",
Keep with next, Tab stops: Not at 1.75" + 3"

With a copy to: ~~[]~~Legal Department
Eversource Energy
800 Boylston Street / P1701
Boston MA 02199

Formatted: Normal, Indent: Left: 0.5", Hanging: 1.25",
Tab stops: Not at 1.75" + 3"

If to Seller: ~~[]~~ Suite 510, Bank Plaza, 700 Pleasant Street
With a copy to: ~~[]~~ New Bedford MA 02740
attn: Lars Pedersen
E-mail: lpedersen@vineyardwind.com

Formatted: Normal, Indent: First line: 0.5", Tab stops:
1.56", Left + Not at 3"

Formatted: Normal, Indent: First line: 0.5", Tab stops:
1.56", Left + Not at 3"

18. WAIVER AND MODIFICATION

This Agreement may be amended and its provisions and the effects thereof waived only by a writing executed by the Parties, and no subsequent conduct of any Party or course of dealings between the Parties shall effect or be deemed to effect any such amendment or waiver. No waiver of any of the provisions of this Agreement shall be deemed or shall constitute a waiver of any other provision hereof (whether or not similar), nor shall such waiver constitute a continuing waiver unless otherwise expressly provided. The failure of either Party to enforce any provision of this Agreement shall not be construed as a waiver of or acquiescence in or to such provision. Buyer shall determine in its sole discretion whether any amendment or waiver of the provisions of this Agreement shall require Regulatory Approval or MDPU filing and/or approval. If Buyer determines that any such approval or filing is required, then such amendment or waiver shall not become effective unless and until Regulatory Approval or such other approval is received, or such MDPU filing is made and any requested MDPU approval is received.

19. INTERPRETATION

19.1 Choice of Law. Interpretation and performance of this Agreement shall be in accordance with, and shall be controlled by, the laws of the Commonwealth of Massachusetts (without regard to its principles of conflicts of law).

19.2 Headings. Article and Section headings are for convenience only and shall not affect the interpretation of this Agreement. References to articles, sections and exhibits are, unless the context otherwise requires, references to articles, sections and exhibits of this Agreement. The words "hereof" and "hereunder" shall refer to this Agreement as a whole and not to any particular provision of this Agreement.

19.3 Forward Contract. The Parties acknowledge and agree that this Agreement and the transactions contemplated hereunder are a "forward contract" within the meaning of the United States Bankruptcy Code.

19.4 Standard of Review. The Parties acknowledge and agree that the standard of review for any avoidance, breach, rejection, termination or other cessation of performance or changes to any portion of this integrated, non-severable Agreement (as described in Section 22) over which FERC has jurisdiction, whether proposed by Seller, by Buyer, by a non-party of, by FERC acting *sua sponte* shall be the “public interest” standard of review set forth in United Gas Pipe Line Co. v. Mobile Gas Serv. Co., 350 U.S. 332 (1956) and Federal Power Comm’n v. Sierra Pac. Power Co., 350 U.S. 348 (1956). Each Party agrees that if it seeks to amend any applicable power sales tariff during the Term, such amendment shall not in any way materially and adversely affect this Agreement without the prior written consent of the other Party. Each Party further agrees that it shall not assert, or defend itself, on the basis that any applicable tariff is inconsistent with this Agreement.

19.5 Change in ISO-NE Rules and Practices. This Agreement is subject to the ISO-NE Rules and ISO-NE Practices. If, during the Term of this Agreement, any ISO-NE Rule or ISO-NE Practice is terminated, modified or amended or is otherwise no longer applicable, resulting in a material alteration of a material right or obligation of a Party hereunder, the Parties agree to negotiate in good faith in an attempt to amend or clarify this Agreement to embody the Parties’ original intent regarding their respective rights and obligations under this Agreement, provided that neither Party shall have any obligation to agree to any particular amendment or clarification of this Agreement. The intent of the Parties is that any such amendment or clarification reflect, as closely as possible, the intent, substance and effect of the ISO-NE Rule or ISO-NE Practice being replaced, modified, amended or made inapplicable as such ISO-NE Rule or ISO-NE Practice was in effect prior to such termination, modification, amendment, or inapplicability, provided that such amendment or clarification shall not in any event alter (i) the purchase and sale obligations of the Parties pursuant to this Agreement, or (ii) the Price ~~for the Adjusted Price, as applicable~~ National Grid.

19.6 Dodd Frank Act Representations. The Parties agree that this Agreement (including all transactions reflected herein) is not a “swap” within the meaning of the Commodity Exchange Act ~~(“CEA”)~~ and the rules, interpretations and other guidance of the Commodity Futures Trading Commission (“CFTC rules”), and that the primary intent of this Agreement is physical settlement (i.e., actual transfer of ownership) of the nonfinancial commodity and not solely to transfer price risk. In reliance upon such agreement, each Party represents to the other that:

(a) With respect to the commodity to be purchased and sold hereunder, it is a commercial market participant, a commercial entity and a commercial party, as such terms are used in the CFTC rules, and it is a producer, processor, or commercial user of, or a merchant handling, the commodity and it is entering into this Agreement for purposes related to its business as such;

(b) It is not registered or required to be registered under the CFTC rules as a swap dealer or a major swap participant;

(c) It has entered into this Agreement in connection with the conduct of its regular business and it has the capacity or ability to regularly make or take delivery of the commodity to be purchased and sold hereunder;

(d) With respect to the commodity to be purchased and sold hereunder, it intends to make or take physical delivery of the commodity;

(e) At the time that the Parties enter into this Agreement, any embedded volumetric optionality in this Agreement is primarily intended by the holder of such option or optionality to address physical factors or regulatory requirements that reasonably influence demand for, or supply of, the commodity to be purchased and sold hereunder;

(f) With respect to any embedded commodity option in this Agreement, such option is intended to be physically settled so that, if exercised, the option would result in the sale of the commodity to be purchased or sold hereunder for immediate or deferred shipment or delivery;

(g) The commodity to be purchased and sold hereunder is a nonfinancial commodity, and is also an exempt commodity or an agricultural commodity, as such terms are defined and interpreted in the CFTC rules.

To the extent that reporting of any transactions related to this Agreement is required by the CFTC rules, the Parties agree that Seller shall be responsible for such reporting (the "Reporting Party"). The Reporting Party's reporting obligations shall continue until the reporting obligation has expired or has been terminated in accordance with CFTC rules. The Buyer, as the Party that is not undertaking the reporting obligations shall timely provide the Reporting Party all necessary information requested by the Reporting Party for it to comply with CFTC rules.

19.7 Change in Law or Buyer's Accounting Treatment, Subsequent Judicial or Regulatory Action. If, during the Term of this Agreement, there is a change in Law or accounting standards or rules or a change in the interpretation or applicability thereof that would result in adverse balance sheet or creditworthiness impacts on Buyer associated with this Agreement or the amounts paid for Products purchased hereunder, the ~~Buyer shall prepare an amendment~~ Parties agree to amend this Agreement to avoid or significantly mitigate such impacts. ~~Buyer shall use commercially reasonable efforts to prepare such amendment in a manner that mitigates any material adverse effect(s) on Seller (as identified by Seller, acting reasonably) that could reasonably be expected to result from such amendment, but only to while preserving the extent that such mitigation can be accomplished in a manner that is consistent with existing terms of the purpose of such amendment. Seller agrees to execute such amendment provided that such amendment does~~ Agreement not (unless the Seller otherwise agrees) alter: impacted by such change(s), and further such amendment shall not in any event alter: (i) the purchase and sale obligations of the Parties pursuant to this Agreement, or (ii) the Price ~~for.~~ In the event that the Adjusted Price, as applicable — National Grid — Parties cannot agree on such amendment with sixty (60) days after the change described above necessitating such amendment, the Dispute regarding such amendment will be resolved in accordance with Article 11.

Upon a determination by a court or regulatory body having jurisdiction over this Agreement or any of the Parties hereto, or over the establishment and enforcement of any of the statutes or regulations or orders or actions of regulatory agencies (including the MDPU) supporting this Agreement or the rights or obligations of the Parties hereunder that any of the statutes or regulations supporting this Agreement or the rights or obligations of the Parties hereunder, or

orders of or actions of regulatory agencies (including the MDPU) implementing such statutes or regulations, or this Agreement on its face or as applied, violates any Law (including the State or Federal Constitution) (an "Adverse Determination"), each Party shall have the right to suspend performance under this Agreement without liability. Seller may deliver and sell Products to a third party during any period of time for which Buyer suspends payments or purchases under this Section. Upon an Adverse Determination becoming final and non-appealable, this Agreement shall be rendered null and void.

20. COUNTERPARTS; FACSIMILE SIGNATURES

Any number of counterparts of this Agreement may be executed, and each shall have the same force and effect as an original. Facsimile signatures hereon or on any notice or other instrument delivered under this Agreement shall have the same force and effect as original signatures.

21. NO DUTY TO THIRD PARTIES

Except as provided in any consent to assignment of this Agreement, nothing in this Agreement nor any action taken hereunder shall be construed to create any duty, liability or standard of care to any Person not a Party to this Agreement.

22. SEVERABILITY

If any term or provision of this Agreement or the interpretation or application of any term or provision to any prior circumstance is held to be unenforceable, illegal or invalid by a court or agency of competent jurisdiction, the remainder of this Agreement and the interpretation or application of all other terms or provisions to Persons or circumstances other than those which are unenforceable, illegal or invalid shall not be affected thereby, and each term and provision shall be valid and be enforced to the fullest extent permitted by law so long as all essential terms and conditions of this Agreement for both Parties remain valid, binding and enforceable and have not been declared to be unenforceable, illegal or invalid by a Governmental Entity of competent jurisdiction. The Parties acknowledge and agree that essential terms and conditions of this Agreement for each Party include, without limitation, all pricing and payment terms and conditions of this Agreement, and that the essential terms and conditions of this Agreement for Buyer also include, without limitation, the terms and conditions of Section 19.67 of this Agreement.

23. INDEPENDENT CONTRACTOR

Nothing in this Agreement shall be construed as creating any relationship between Buyer and Seller other than that of Seller as independent contractor for the sale of Products, and Buyer as principal and purchaser of the same. Neither Party shall be deemed to be the agent of the other Party for any purpose by reason of this Agreement, and no partnership or joint venture or fiduciary relationship between the Parties is intended to be created hereby. Nothing in this Agreement shall be construed as creating any relationship between Buyer and the Interconnecting Utility.

24. ENTIRE AGREEMENT

This Agreement shall constitute the entire agreement and understanding between the Parties hereto and shall supersede all prior agreements and communications.

[Signature page follows]

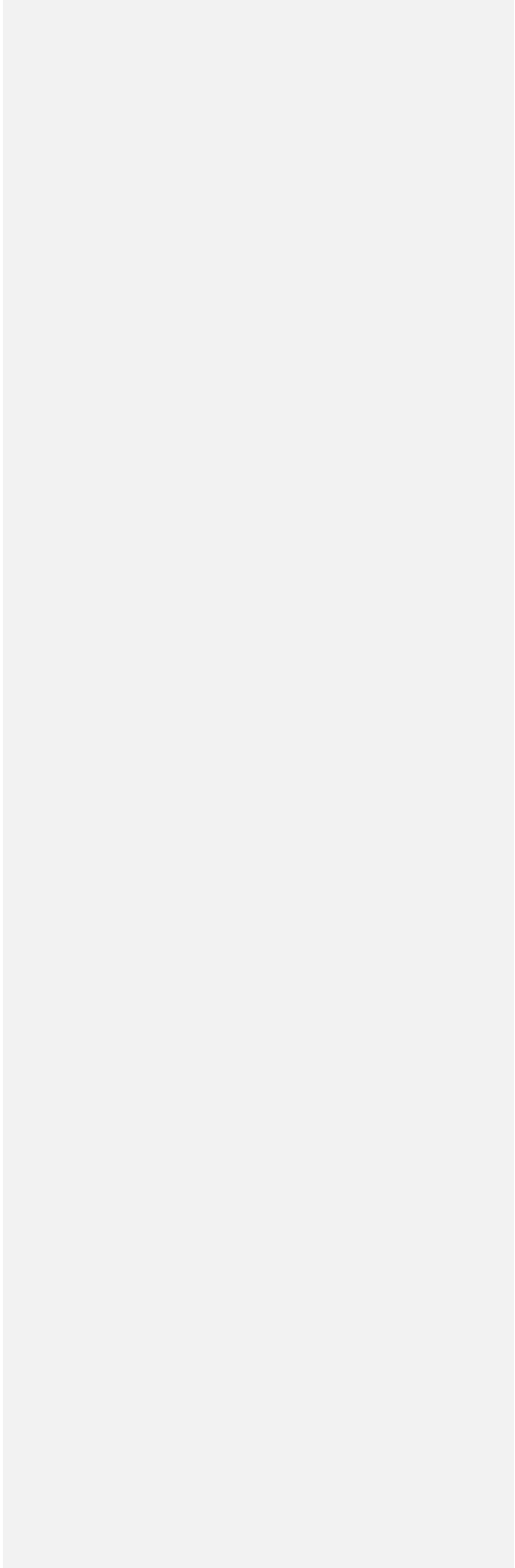

IN WITNESS WHEREOF, each of Buyer and Seller has caused this Agreement to be duly executed on its behalf as of the date first above written.

{Buyer}

NSTAR ELECTRIC COMPANY d/b/a EVERSOURCE ENERGY, as Buyer

By: _____

Name:

Title:

{VINEYARD WIND LLC, as Seller}

By: _____

Name:

Title:

Draft
5-10-2017

EXHIBIT A

Formatted: Font: Italic

DESCRIPTION OF FACILITY

(Subject to update as provided in Section 3.3(f))

Facility: ~~[Note to Bidder: Describe fully Those certain turbines, identified below, owned or controlled by Seller within the offshore wind facility]~~

Delivery Point: ~~[Note OCS-A, 0501 lease area and designated by Seller to Bidder: When specifying be included in the Delivery Point in this Exhibit A, this location should be defined as a PTF node such that Facility (the EDCs are aggregate nameplate capacity of which will not responsible for wheeling charges or other exceed 400 MW), and related charges (e.g., transmission interconnection, service and delivery charges, including all related administrative fees and other charges in connection with shared equipment necessary to deliver the Delivery of~~

Energy Product to the Delivery Point)-1.

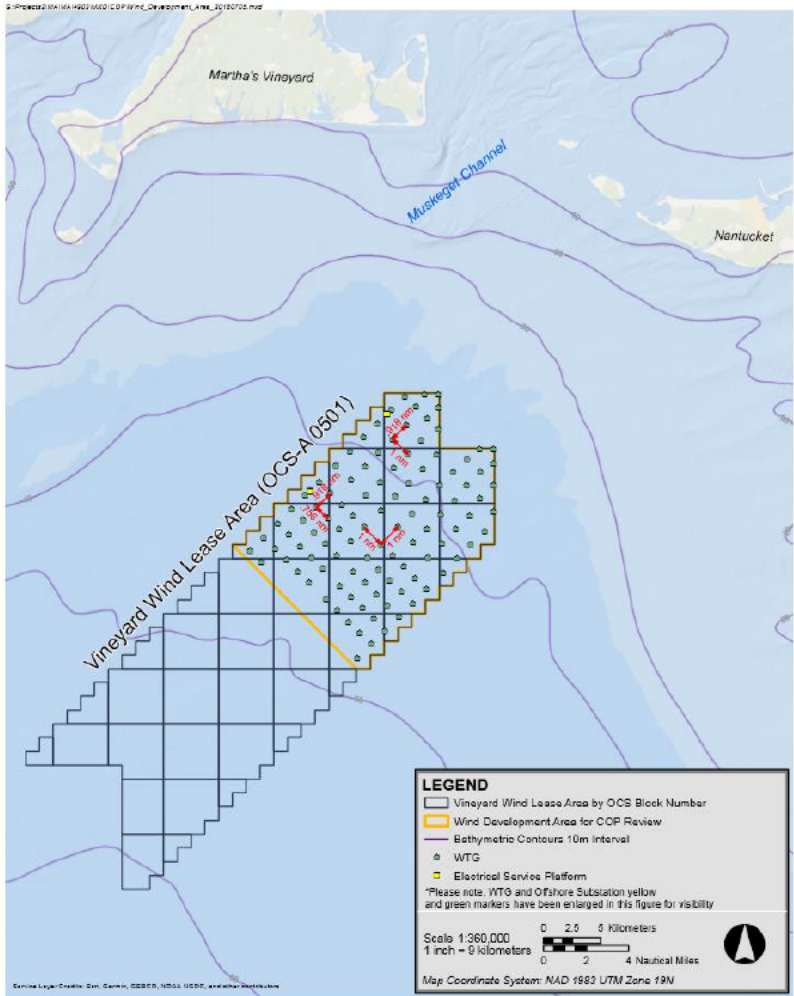

Vineyard Wind Project

<u>Turbine</u>	<u>Serial Number</u>	<u>Turbine</u>	<u>Serial Number</u>
<u>1</u>	<u>To be identified</u>	<u>26</u>	<u>To be identified</u>
<u>2</u>	<u>To be identified</u>	<u>27</u>	<u>To be identified</u>
<u>3</u>	<u>To be identified</u>	<u>28</u>	<u>To be identified</u>
<u>4</u>	<u>To be identified</u>	<u>29</u>	<u>To be identified</u>
<u>5</u>	<u>To be identified</u>	<u>30</u>	<u>To be identified</u>

<u>6</u>	<u>To be identified</u>	<u>31</u>	<u>To be identified</u>
<u>7</u>	<u>To be identified</u>	<u>32</u>	<u>To be identified</u>
<u>8</u>	<u>To be identified</u>	<u>33</u>	<u>To be identified</u>
<u>9</u>	<u>To be identified</u>	<u>34</u>	<u>To be identified</u>
<u>10</u>	<u>To be identified</u>	<u>35</u>	<u>To be identified</u>
<u>11</u>	<u>To be identified</u>	<u>36</u>	<u>To be identified</u>
<u>12</u>	<u>To be identified</u>	<u>37</u>	<u>To be identified</u>
<u>13</u>	<u>To be identified</u>	<u>38</u>	<u>To be identified</u>
<u>14</u>	<u>To be identified</u>	<u>39</u>	<u>To be identified</u>
<u>15</u>	<u>To be identified</u>	<u>40</u>	<u>To be identified</u>
<u>16</u>	<u>To be identified</u>	<u>41</u>	<u>(if necessary)</u>
<u>17</u>	<u>To be identified</u>	<u>42</u>	<u>(if necessary)</u>
<u>18</u>	<u>To be identified</u>	<u>43</u>	<u>(if necessary)</u>
<u>19</u>	<u>To be identified</u>	<u>44</u>	<u>(if necessary)</u>
<u>20</u>	<u>To be identified</u>	<u>45</u>	<u>(if necessary)</u>
<u>21</u>	<u>To be identified</u>	<u>46</u>	<u>(if necessary)</u>
<u>22</u>	<u>To be identified</u>	<u>47</u>	<u>(if necessary)</u>
<u>23</u>	<u>To be identified</u>	<u>48</u>	<u>(if necessary)</u>
<u>24</u>	<u>To be identified</u>	<u>49</u>	<u>(if necessary)</u>
<u>25</u>	<u>To be identified</u>	<u>50</u>	<u>(if necessary)</u>

Delivery Point:

ISO-NE PTF Node: _____To Be Determined
by ISO-NE after the establishment of the PTF Node at the Barnstable 115kV substation.

~~Proposed~~Expected Nameplate Capacity: 400 MW

Actual Facility Size: (Nameplate capacity of the Facility as provided with bid, expressed in MWs {AC})(to be completed upon achievement of Commercial Operations)

Formatted: Font: Bold

~~Draft~~
5-10-2017

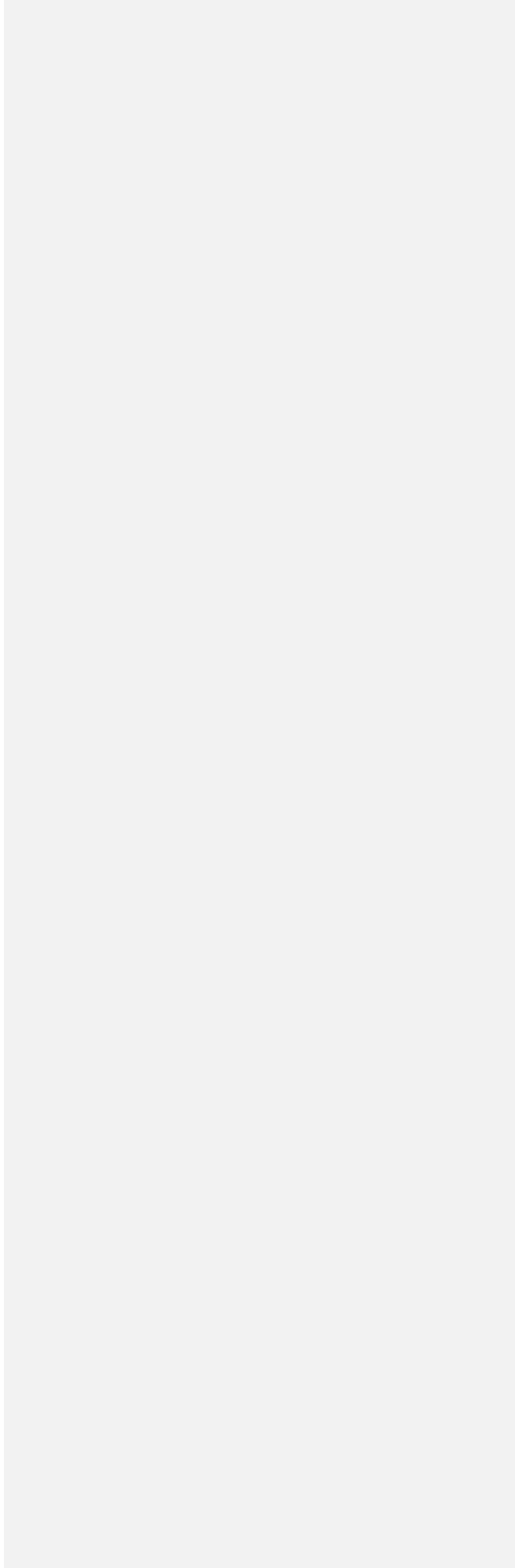

Shared Equipment

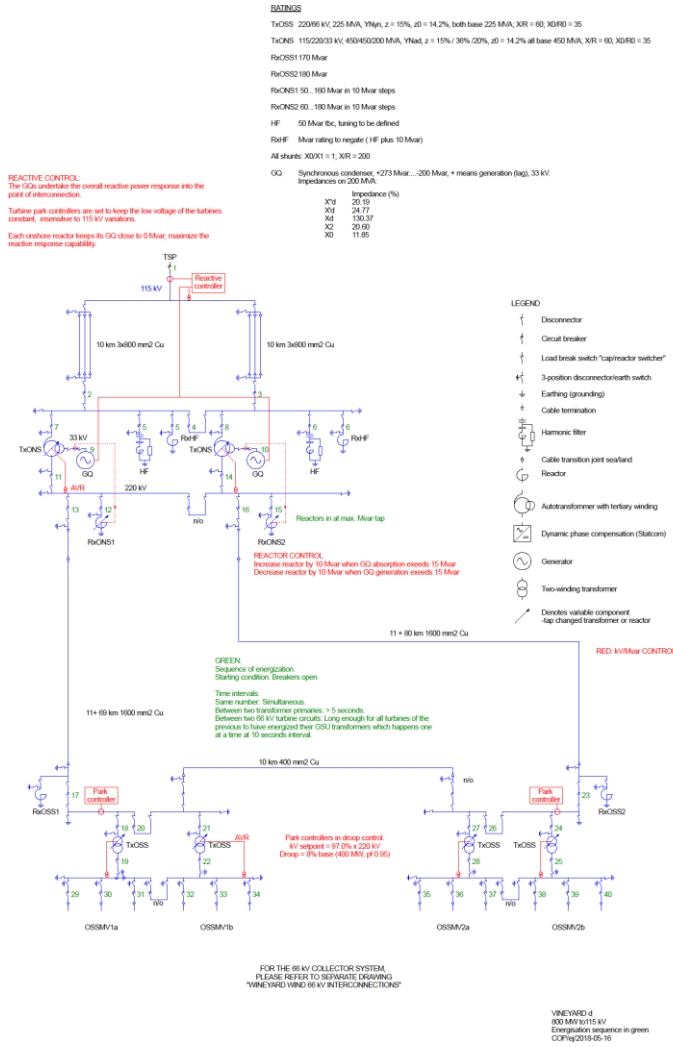

PRELIMINARY DESIGN TO BE REPLACED WITH FINAL INSTALLED

Cable Route

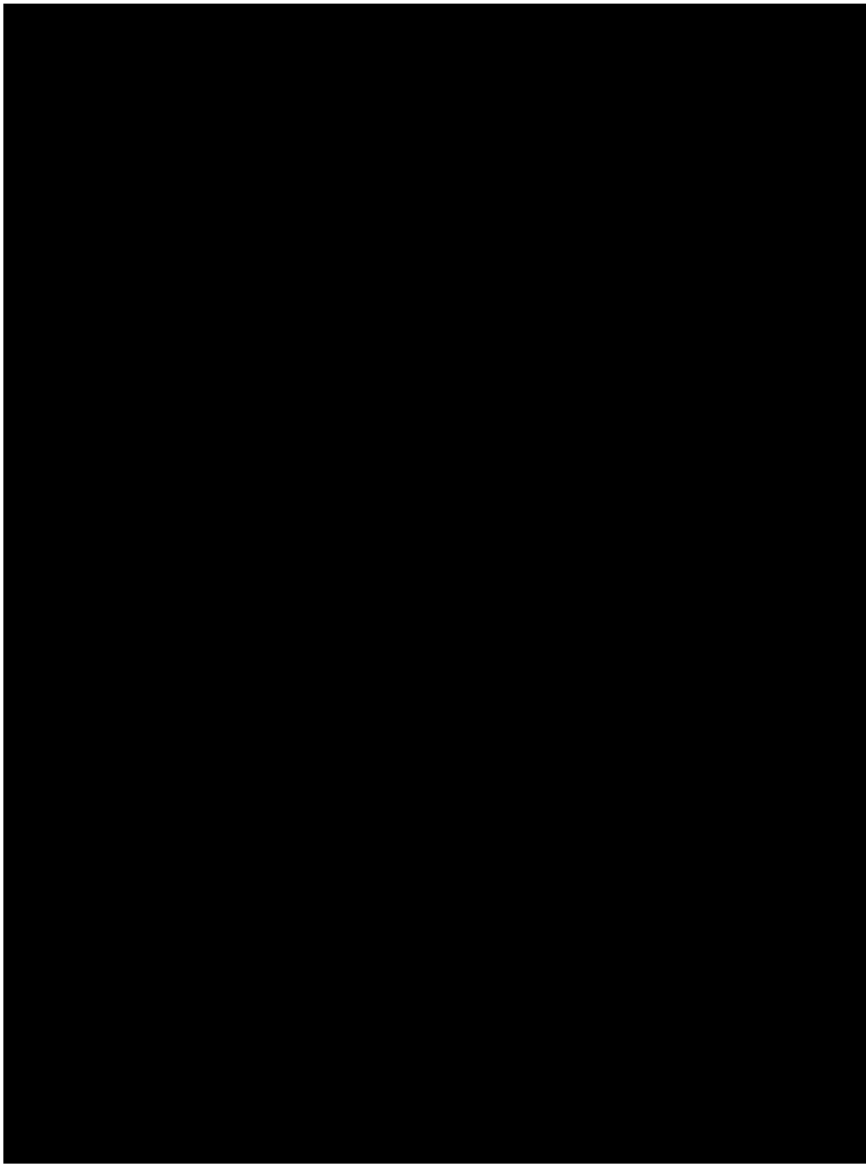

Draft

5-10-2017

EXHIBIT B

Formatted: Font: Italic

SELLER'S CRITICAL MILESTONES - PERMITS AND REAL PROPERTY RIGHTS

[To be prepared to conform with the Critical Milestones referenced in Section 3.1]

PERMITS

<u>Agency/Regulatory Authority</u>	<u>Permit/Approval</u>
<u>Federal</u>	
	<u>Site Assessment Plan (SAP) approval</u>
<u>Bureau of Ocean Energy Management (BOEM)</u>	<u>Construction and Operations Plan (COP) approval</u> <u>Consultation under Section 7 of the Endangered Species Act with the National Marine Fisheries Service and US Fish and Wildlife Service</u>
<u>U.S. Environmental Protection Agency (EPA)</u>	<u>National Pollutant Discharge Elimination System (NPDES) General Permit for Construction Activities</u> <u>Outer Continental Shelf Air Permit</u>
<u>U.S. Army Corps of Engineers (USACE)</u>	<u>Individual Clean Water Act Section 404</u> <u>Rivers and Harbors Act of 1899 Section 10 Permit</u>
<u>U.S. National Marine Fisheries Service</u>	<u>Incidental Harassment Authorization (IHA) or</u> <u>Letter of Authorization (LOA)</u>
<u>U.S. Coast Guard</u>	<u>Private Aids to Navigation authorization</u>
<u>Federal Aviation Administration</u>	<u>No Hazard Determination</u>
<u>State/Massachusetts (for portions of the Project within state jurisdiction)</u>	
<u>Massachusetts Environmental Policy Act Office</u>	<u>Certificate of Secretary of Energy and Environmental Affairs on Final Environmental Impact Report</u>
<u>Energy Facilities Siting Board</u>	<u>G.L. c. 164 § 69 Approval</u>
<u>Massachusetts Department of Public Utilities</u>	<u>G.L. c. 164 § 72 Approval to Construct</u> <u>G.L. c. 40A § 3 Zoning Exemption (if needed)</u>
<u>Massachusetts Department of Environmental Protection</u>	<u>Chapter 91 Waterways License</u> <u>Water Quality Certification (Section 401 of the Clean Water Act)</u> <u>Approval of Easement (drinking water regulations if needed)</u>
<u>Massachusetts Department of Transportation</u>	<u>Road Crossing Permits/Non-Vehicular Access Permits</u> <u>Rail Division Use and Occupancy License</u>
<u>Natural Heritage and Endangered Species Program (NHESP)</u>	<u>Conservation and Management Permit (if needed)</u>
<u>Regional (for portions of the Project within regional jurisdiction)</u>	
<u>Cape Cod Commission (Barnstable County)</u>	<u>Development of Regional Impact (DRI) Review</u>

Formatted: Footer

<i>Agency/Regulatory Authority</i>	<i>Permit/Approval</i>
<u>Martha's Vineyard Commission</u>	<u>DRI Review (if needed)</u>

<u>Local (for portions of the Project within local jurisdiction)</u>	
<u>Yarmouth and Barnstable Conservation Commissions</u>	<u>Order of Conditions (Massachusetts Wetlands Protection Act and municipal wetland non zoning bylaws)</u>
<u>Yarmouth DPW and/or Board of Selectmen</u>	<u>Street Opening Permits/Grants of Location</u>
<u>Barnstable DPW and/or Town Council</u>	<u>Street Opening Permits/Grants of Location</u>
<u>Barnstable Planning/Zoning</u>	<u>Zoning approvals as necessary</u>
<u>Edgartown Nantucket and/or Mashpee Conservation Commissions</u>	<u>Order of Conditions (Massachusetts Wetlands Protection Act and municipal wetland non zoning bylaws) (if needed as dictated by final submarine route)</u>

REAL PROPERTY RIGHTS

Seller has identified alternative routes including lands and real property over which it may be required to secure rights and alternative locations in which it may locate certain assets and operations of the Facility. The following list of property rights, including for on-shore cable routes may include, but are not necessarily limited to: grants of locations (for public ways), easements from government and private property owners (land not in public ways), licenses, rights of co-location (utility rights of way), and potentially fee interests. Acquisition of some of these interests, if required, may require legislative and other approvals pursuant to state and local law and Article 97 of the Massachusetts Constitution. The specific property rights that will be required may change depending on the specific route selected, historical title issues, the nature of the rights required, and other factors. Not all rights will be required for all potential routes and not all of the property rights identified in this Exhibit B may ultimately be required in order for Seller to achieve the Commercial Operation Date.

<u>Property right required</u>
<u>Land for substation</u>
<u>Onshore cable route-Yarmouth portion (Preferred Route only)</u>
<u>Onshore cable route-Barnstable portion (Required for both Preferred and Alternate Routes)</u>
<u>Onshore cable route alternative -Bike path route in Barnstable (Preferred Route only)</u>
<u>Onshore cable route alternative -Utility ROW</u>
<u>Onshore cable route alternate-MA DOT rail way</u>

Onshore cable route crossing of state highways (two or three crossings depending on route variant).

Offshore cable route-state waters

Offshore cable route –Federal waters

Wind turbines inter-array cable and offshore substation locations

Construction port

Draft
5-10-2017

EXHIBIT C
FORM OF PROGRESS REPORT

For the Quarter Ending: _____

Milestones Achieved:

Milestones Pending:

Status of Progress toward achievement of Critical Milestones during the quarter:

Status of permitting and Permits obtained during the quarter:

Status of Financing for Facility:

Current projection for Financial Closing Date:

Events expected to result in delays in achievement of any Critical Milestones:

Critical Milestones not yet achieved and projected date for achievement:

Current projection for Commercial Operation Date:

If the ~~market price~~LMP at the Delivery Point in the Real-Time ~~or Day Ahead markets, as applicable, Energy Market~~ for Energy Delivered by Seller is negative in any hour, the payment to Seller for ~~deliveries~~Deliveries of Energy shall be reduced by the difference between the absolute value of the hourly LMP at the Delivery Point and \$0.00 per MWh for that Energy for each such hour. Each monthly invoice shall reflect a reduction for all hours in the applicable month in which the LMP for the Energy at the Delivery Point is less than \$0.00 per MWh.

Examples. If ~~delivered~~Delivered Energy equals 1 MWh and Price equals \$50.00/MWh:

LMP at the Delivery Point equals (or is greater than) \$0.00/MWh
 Buyer payment of Price to Seller \$50.00
 Seller credit/reimbursement for negative LMP to Buyer \$0.00
 Net Result: Buyer pays Seller \$50 for that hour

LMP at the Delivery Point equals -\$150.00/MWh
 Buyer payment of Price to Seller \$50.00
 Seller credit/reimbursement for negative LMP to Buyer \$150.00
 Net Result: Seller credits or reimburses Buyer \$100 for that hour

~~(b) Price for Buyer's Percentage Entitlement of Products Delivered in Excess of Contract Maximum Amount. The Products Delivered in excess of the Contract Maximum Amount shall be purchased by Buyer at a Price equal to the product of (x) the MWhs of Energy in excess of the Contract Maximum Amount Delivered to the Delivery Point and (y) the lesser of (i) ninety percent (90%) of the Real Time LMP at such Delivery Point, or (ii) the Price determined in accordance with Section 1(a) of this Exhibit D for each hour of the month during which such Energy in excess of the Contract Maximum Amount is Delivered to Buyer.~~

~~(c) Negative LMP—For those hours when the Real Time LMP at the Delivery Point (as determined by ISO-NE) is negative, the payment from Buyer to Seller shall be reduced for Products Delivered in excess of the Contract Maximum Amount by an amount equal to the product of (x) the MWhs of Energy in excess of the Contract Maximum Amount Delivered to the Delivery Point and (y) one hundred percent (100%) of the absolute value of the Real Time LMP at such Delivery Point for each hour of the month during which such Energy in excess of the Contract Maximum Amount is Delivered to Buyer. All rights and title to RECs associated with Energy Delivered in excess of the Contract Maximum Amount shall remain with Buyer whether the Real Time LMP is positive or negative. In the event that Seller received RECs associated with Energy Delivered in excess of the Contract Maximum Amount, Seller shall not hold or claim to hold equitable title to such RECs and shall promptly transfer such RECs to Buyer's GIS account.~~

~~EXHIBIT E~~
~~RELATED TRANSMISSION FACILITIES~~

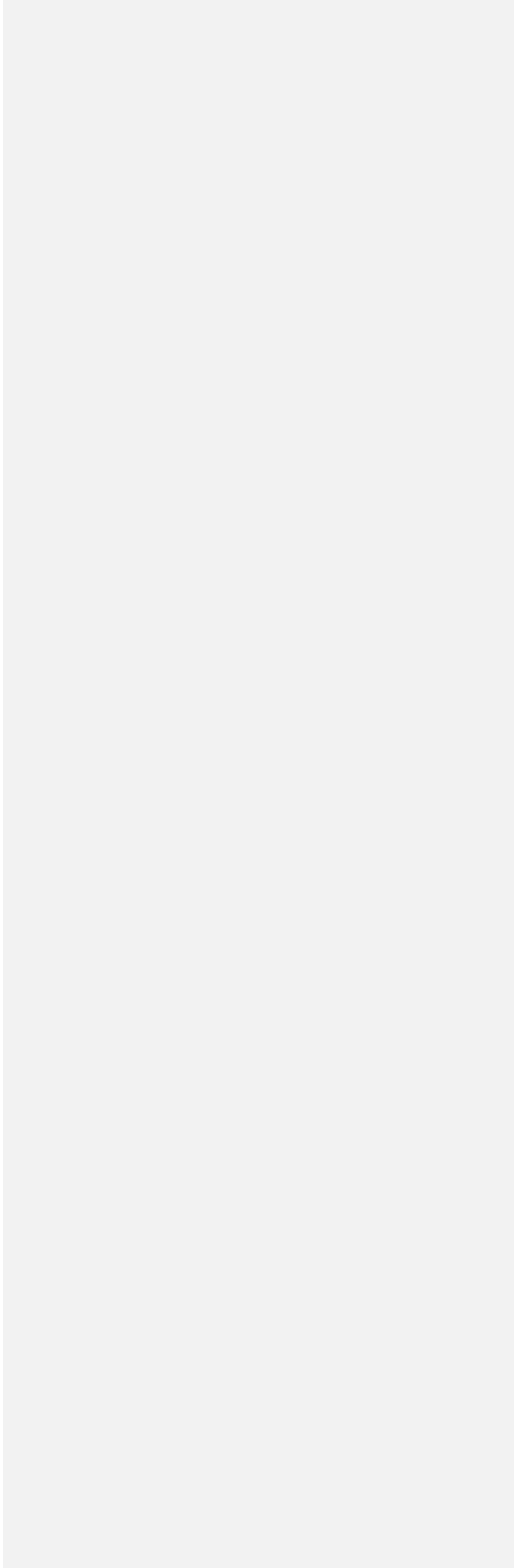

EXHIBIT E

METERING PROCESS

The Energy generated in any hour (or shorter settlement period applicable under the ISO-NE Rules) (the "Settlement Period") by the Facility and the Other Facility (including any Energy not included in the Products or the Products being purchased under the Other Facility Agreement) will be allocated between the Facility and the Other Facility, and attributed to Energy being purchased by Buyer hereunder and under the Other Facility Agreement, as follows:

FM = the sum of the volumes on all Meters installed prior to the electrical service platform that measure only the output of the wind turbines included in the Facility over the relevant Settlement Period

OFM = the sum of the volumes on all Meters installed prior to the electrical service platform that measure only the output of the wind turbines included in the Other Facility over the relevant Settlement Period

$$\text{Facility Volume Ratio ("FVR")} = \frac{\text{FM}}{\text{FM} + \text{OFM}}$$

$$\text{Other Facility Volume Ratio ("OFVR")} = \frac{\text{OFM}}{\text{FM} + \text{OFM}}$$

The combined Energy of the Facility and the Other Facility during each Settlement Period ("E"), as measured by the Meter(s) at the Delivery Point, will be allocated between the Facility and the Other Facility as follows:

Energy allocated to the Facility ("FE") = E x FVR

Energy allocated to the Other Facility = E x OFVR

The Energy (and associated RECs) to be purchased by Buyer under this Agreement during any Settlement Period shall be determined by the following formula:

(FE – TE – ACPE) x BPE, where

"FE" is the Energy allocated to the Facility for such Settlement Period, as described above

"TE" is any Energy produced during the Settlement Period when the Settlement Period occurs during the Test Period with respect to the Facility

"ACPE" is Energy (i) produced during the Settlement Period by portions of the Facility completed during the Additional Construction Period and (ii) produced prior to the delivery of the Additional Construction IE Certificate, and

BPE is the Buyer's Percentage Entitlement

Each Internal Bilateral Transaction submitted by Seller under Section 4.2(a) will be consistent with this Exhibit E, and any TE or ACPE calculations will be based on SCADA data produced by the Facility and the Other Facility, as applicable. Seller will provide such SCADA data for the Facility and the Other Facility with each invoice delivered to Buyer under the Agreement.

The following schematic shows the meters approach described in this Exhibit E:

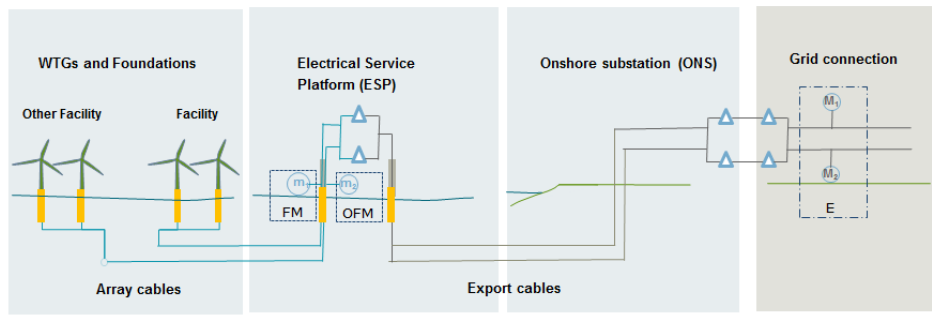

Draft
5-10-2017

EXHIBIT F

RESERVED

This page intentionally blank

EXHIBIT G

INSURANCE

Workers' Compensation and Employers' Liability Insurance as required by the applicable law. Coverage shall include the U.S. Longshoremen's and Harbor Workers' Compensation Act and the Jones Act;

Commercial General Liability (CGL) Insurance, covering all operations to be performed under the Agreement, with minimum limits of:

Combined Single Limit \$10,000,000 per occurrence

General Aggregate and
 Product Aggregate \$10,000,000

This policy shall include Contractual Liability and Products-Completed Operations coverage. If the Products-Completed Operations coverage is written on a claims-made basis, coverage shall be maintained continuously for at least two (2) years after acceptance of work completed in accordance with the Agreement.

Any combination of General Liability and Umbrella/Excess liability policy limits can be used to satisfy the limit requirement stated above.

Automobile Liability, covering all owned, non-owned and hired vehicles used in connection with the provisions of the Products with minimum limits of:

Combined Single Limit \$1,000,000 per occurrence

Watercraft Liability, which may be carried by the contractor of Seller providing such services applicable to the watercraft liability insurance, with the same minimum limits of:

Combined Single Limit \$1,000,000 per occurrence

General Aggregate and
 Product Aggregate \$2,000,000

Aircraft Liability, if the provision of the Products requires the use of aircraft, with a limit of liability of not less than \$10,000,000 combined single limit.

Professional Liability coverage, which may be carried by the contractor of Seller providing such services applicable to the professional liability insurance, if professional services are required, with a limit of liability of the greater of \$5,000,000 or the value of the Purchase Order.

Other insurance as required and as mutually agreed upon by the Buyer and the Seller.

Self-Insurance: Proof of qualification as a qualified self-insurer, if approved in advance in writing by the Buyer, will be acceptable in lieu of securing and maintaining one or more of the coverages required in this Exhibit.

Formatted: B Body